

Panel processing

Leitz Lexicon Edition 7

Version 3

06/2023



Explanation of abbreviations

A	= dimension A	LH	= left hand rotation
a_e	= cutting thickness (radial)	M	= metric thread
a_p	= cutting depth (axial)	MBM	= minimum order quantity
ABM	= dimension	MC	= multi-purpose steel, coated
APL	= panel raising length	MD	= thickness of knife
APT	= panel raising depth	min^{-1}	= revolutions per minute (RPM)
AL	= working length	MK	= morse taper
AM	= number of knives	m min^{-1}	= metres per minute
AS	= anti sound (low noise design)	m s^{-1}	= metres per second
b	= overhang	n	= RPM
B	= width	n_{max}	= maximum permissible RPM
BDD	= thickness of shoulder	NAL	= position of hub
BEM	= note	ND	= thickness of hub
BEZ	= description	NH	= zero height
BH	= tipping height	NL	= cutting length
BO	= bore diameter	NLA	= pinhole dimensions
CNC	= Computerized Numerical Control	NT	= grooving depth
d	= diameter	P	= profile
D	= cutting circle diameter	POS	= cutter position
D0	= zero diameter	PT	= profile depth
DA	= outside Diameter	PG	= profile group
DB	= diameter of shoulder	QAL	= cutting material quality
DFC	= Dust Flow Control (optimised chip clearance)	R	= radius
DGL	= number of links	RD	= right hand twist
DIK	= thickness	RH	= right hand rotation
DKN	= double keyway	RP	= radius of cutter
DP	= polycrystalline diamond	S	= shank dimension
DRI	= rotation	SB	= cutting width
FAB	= width of rebate	SET	= set
FAT	= depth of rebate	SLB	= slotting width
FAW	= bevel angle	SLL	= slotting length
FLD	= flange diameter	SLT	= slotting depth
f_z	= tooth feed	SP	= tool steel
$f_{z \text{ eff}}$	= effective tooth feed	ST	= Cobalt-basis cast alloys, e.g. Stellite®
GEW	= thread	STO	= shank tolerance
GL	= total length	SW	= cutting angle
GS	= Plunging edge	TD	= diameter of tool body
H	= height	TDI	= thickness of tool
HC	= tungsten carbide, coated	TG	= pitch
HD	= wood thickness (thickness of workpiece)	TK	= reference diameter
HL	= high-alloyed tool steel	UT	= cutting edges with irregular pitch
HS	= high-speed steel (HSS)	V	= number of spurs
HW	= tungsten carbide (TCT)	v_c	= cutting speed
ID	= ident number	v_f	= feed speed
IV	= insulation glazing	VE	= packing unit
KBZ	= abbreviation	VSB	= adjustment range
KLH	= clamping height	WSS	= workpiece material
KM	= edge breaker	Z	= number of teeth
KN	= single keyway	ZA	= number of fingers
KNL	= combination pinhole consists of 2/7/42 2/9/46,35 2/10/60	ZF	= tooth shape (cutting edge shape)
L	= length	ZL	= finger length
l	= clamping length		
LD	= left hand twist		
LEN	= Leitz standard profiles		

Notes to the Lexicon concerning the diagrams and tables

The statements made in the diagrams and tables relate to specific conditions and represent parameters from tests subjected to defined conditions. Variations when using tools in individual case due to special application conditions may be possible. Our support team will provide you with detailed information.



2. Panel processing

	2.1	Edge processing	2
	2.1.1	Edging processing machines	2
	2.1.2	Jointing cutters	4
	2.1.3	Compact hoggers - DP	15
	2.1.4	Cutting and segment hoggers	20
	2.1.5	Grooving cutters	25
	2.1.6	End trim sawblades	28
	2.1.7	Edge finishing tools	30
<hr/>			
	2.2	Postforming processing	64
	2.2.1	Postforming processing machines	64
	2.2.2	Postforming tools	66
<hr/>			
	2.3	Panel processing	69
	2.3.1	Segment hoggers for sizing	69
<hr/>			
		Troubleshooting	72
<hr/>			
		Signs of wear	73
<hr/>			
		Enquiry/order form special tools – panel processing	75
<hr/>			
		Alphabetical product index	77
<hr/>			
		ID index	78

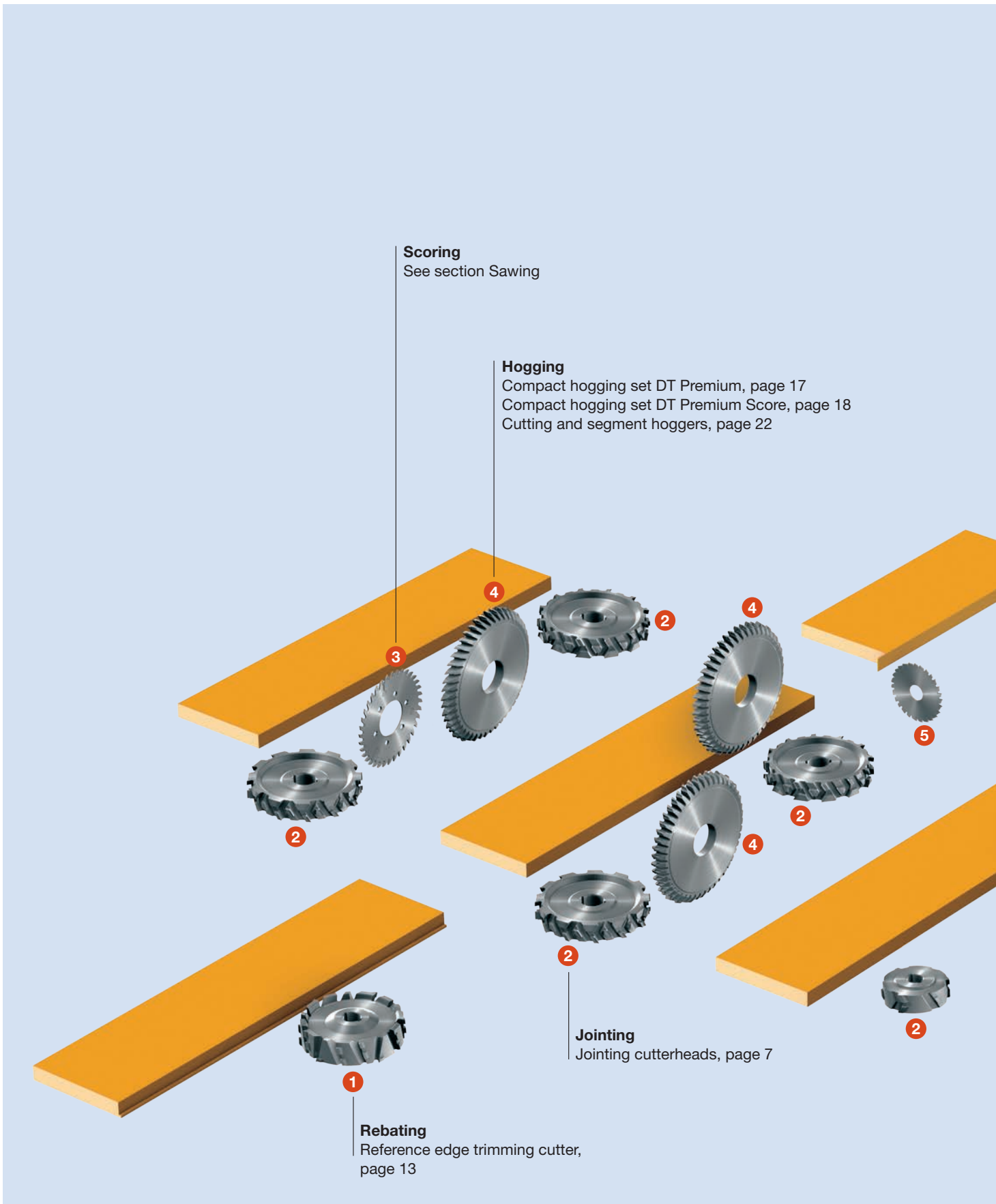

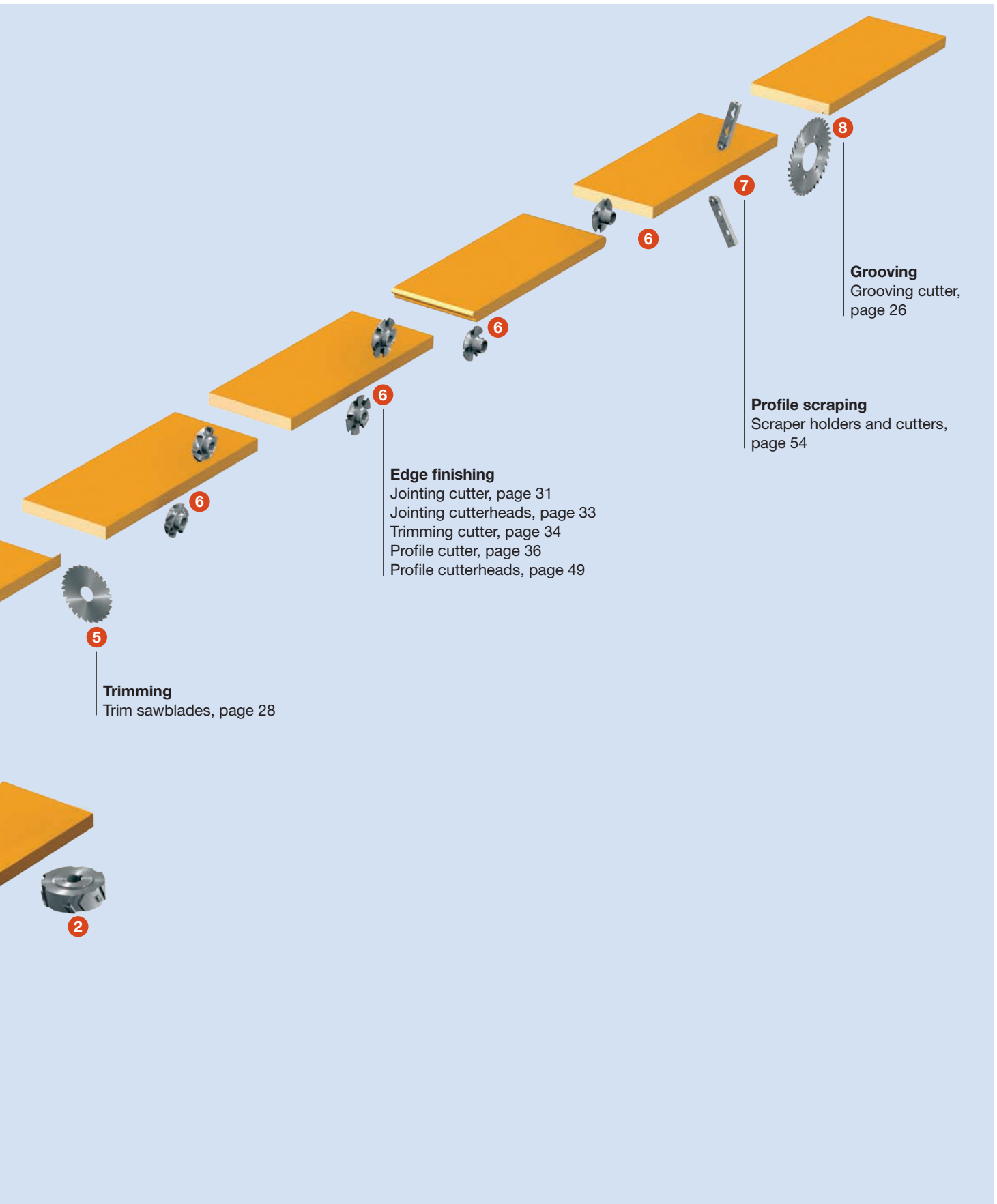

Trimming
Trim sawblades, page 28

Edge finishing
Jointing cutter, page 31
Jointing cutterheads, page 33
Trimming cutter, page 34
Profile cutter, page 36
Profile cutterheads, page 49

Profile scraping
Scraper holders and cutters,
page 54

Grooving
Grooving cutter,
page 26

2.1 Edge processing

2.1.3 Compact hoggers - DP

Process	Hogging along and across the grain, sizing.
Workpiece materials	Chipboard and fibre materials (MDF) uncoated, with plastic or veneer coating.
Machines	Single sided, double-sided machines and double-end tenoners.
Application	Both sizing processes “double hogging” and “scoring/hogging” require two basic hogging types with different cutting geometries: Diamaster DT Premium – Double hogging with feed and negative rake angle and Diamaster DT Premium Score – Scoring/cutting with against feed with positive cutting angle.

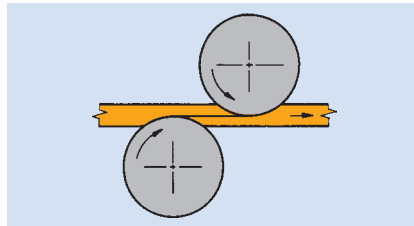

Double hogging: Both hogs cut with feed.

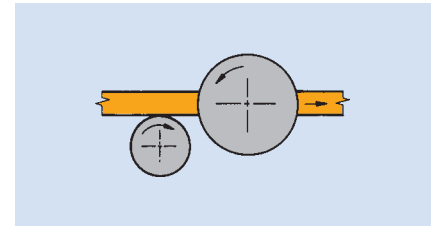

Scoring/hogging: Scoring saw cuts with feed, hogger against feed.

Compact hogger DT Premium	Manufacturers are facing major challenges due to their customers demanding changing quantities as well as requesting a wide variety of carrier and decorative materials to be used in panel production. The new DT Premium compact hogger is the solution for increasing productivity thanks to its long tool life – with perfect quality on the edge and cutting surface.
----------------------------------	--

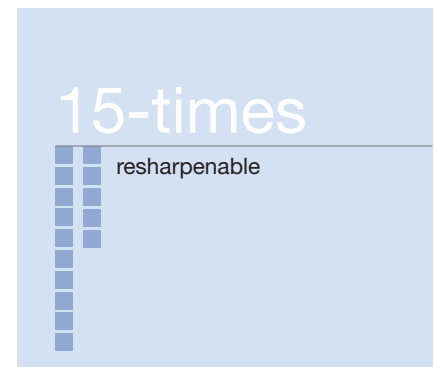
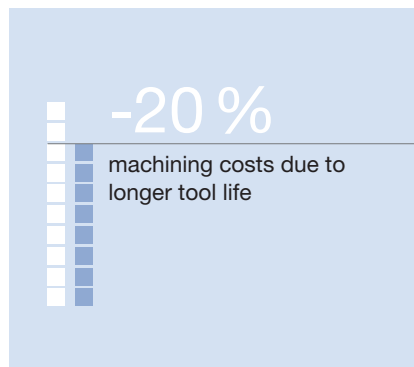

Productivity & efficiency	<p>Maximum economic efficiency through long tool life</p> <ul style="list-style-type: none"> – Long tool life even under difficult operating conditions thanks to new tooth shape – Reduction of set-up costs due to long tool life – Efficient chip removal due to innovative gullet geometry and integrated chipbreaker – Cost efficient processing of various materials – Ideal also for batch size 1 due to adapted cutting geometries – Resharpenable up to 15 times through larger resharpening area
--------------------------------------	--

Quality	<p>Perfect edges and cutting surfaces</p> <ul style="list-style-type: none"> – Excellent edge quality and smooth cutting surfaces through adapted cutting geometries – Clean workpiece finishes due to efficient chip removal with DFC®-Technology – Constant cutting width over the entire life cycle
----------------	---

Sustainability	<p>Longer tool life time, less dust and noise</p> <ul style="list-style-type: none"> – Reduced noise due to special tool design – Reduction of noise and vibration through damping elements – Longer tool life time through larger resharpening area
-----------------------	---

2.1 Edge processing

2.1.3 Compact hoggers - DP

Designs

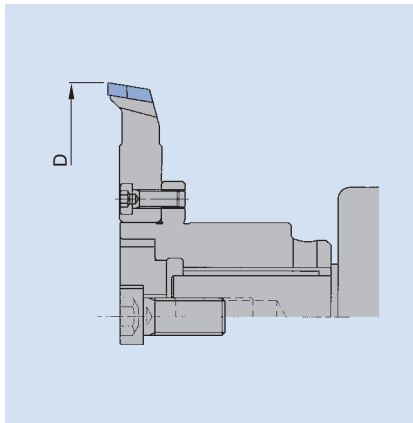

Tooth shape: top bevel decreasing.
Hogger on standard flange.

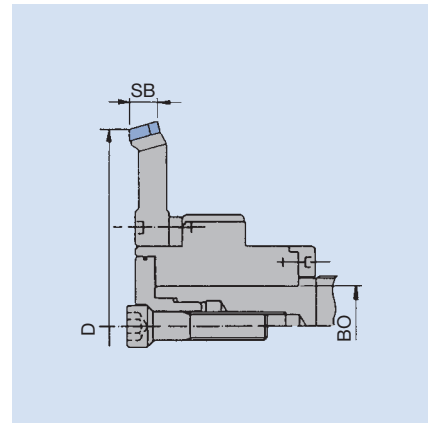

Tooth shape: top bevel increasing.
Hogger on HF hydro sleeve.

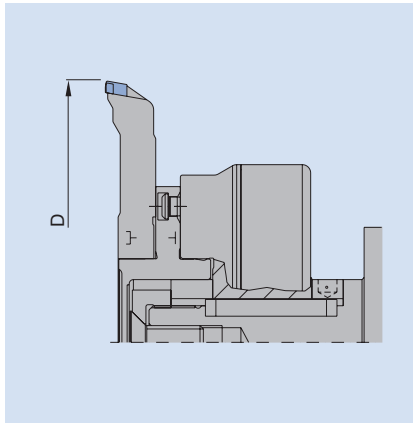

Tooth shape: top bevel decreasing.
Hogger on quick change sleeve.

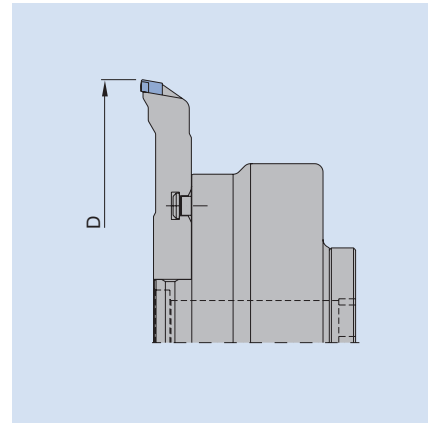

Tooth shape: top bevel decreasing.
Hogger on hydro quick change sleeve.

2. Panel processing

2.1 Edge processing

2.1.2 Jointing cutters

Type of operation	Cutting of the finished size with pre-sized, panel shaped working pieces. Therefore the jointing tools only are peripheral cutting and not with side relief!
Workpiece material	Softwood and hardwood, glulam, chipboard and fibre material, uncoated and veneered, plastic and paper coated.
Machines	Spindle moulders, edgebanding machines with sizing part, double end tenoners. Counter milling or jump cutting: Depending on the processing quantity and material, diamond tools or cutterheads with tungsten carbide turnblades are used.
Application	Jointing against feed: For all panel working materials with or without coating. Jointing with feed: For machining solid wood with heavily irregular course of fibres and risk of tear outs. Only allowed for machines with mechanical feed. Note: Chips are very difficult to remove. Jump cutting: Jointing with and against feed when cutting across, to prevent tear outs on the front and backside of the workpiece when these are already glued.

Tool Designs

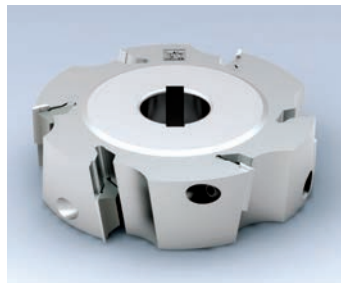

Turnblade cutterhead with alternate shear angle: Suitable for all coated and uncoated panel shaped working materials. Turnblade tools with shear angle produce a curved surface on the workpiece. For exactly straight jointing edges we recommend ProfilCut profile cutterheads with profiled edges (special production) or diamond jointing cutters.

Diamond jointing cutter with alternate shear angle:

S = with symmetrical edge arrangement: Produce a slight hollow section on the milled jointing edge. This has the advantage that the edgebanding on the outside edge close tightly. The tool always must be adjusted symmetrically to the workpiece thickness.

The tool can be used in RH and LH rotation.

AS = Asymmetrical edge arrangement: One cutting edge cuts from bottom to top, the top cutting edges all are directed downward which is advantageous for frequently changing material thicknesses.



2-part tools on synchronically adjustable sleeve:

These tools with alternate shear angles are advantageous for high quantities and nearly constant workpiece thicknesses as with increasing tool blunting the jointing edges on the coating do not remain tear-free. The stepless and synchronic adjustment allows the use of multiple performance times and thus an increase of the tool lifetime.

Diamaster WhisperCut

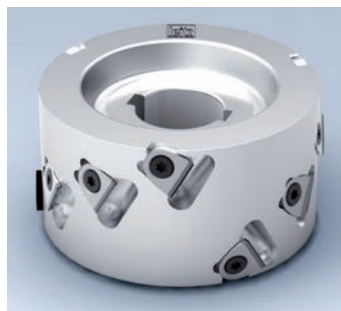

Diamaster WhisperCut – The lightweight and efficient jointing cutterhead for low noise sizing of panel material.

Advantages at a glance:

- Significant noise reduction of up to 5 dB(A) through optimized tool body shape and weight halving
- Trouble free chip ejection and excellent chip collection through DFC technology
- Individual use as per customer requirement: resharpenable or as changing knife system

2. Panel processing

2.1 Edge processing

2.1.2 Jointing cutters

Diamaster EdgeExpert

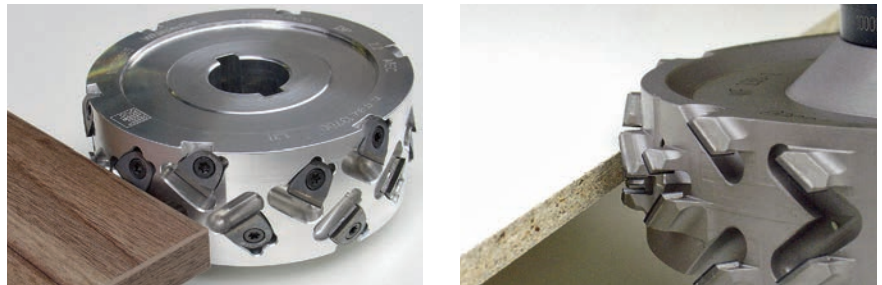

Diamaster EdgeExpert – The expert for top edge performance especially in case of demanding decors.

In interior design and furniture manufacture, the use of processed material surfaces is increasing in both use and importance. This requires new tool concepts such as the Diamaster EdgeExpert program from Leitz. Whether very thin paper decors, veneers or foil- and high-gloss coating, the Diamaster EdgeExpert enables tear-free edges and even middle layer on continuous machines and CNC machining centres. Especially suitable for zero-joint edging technology with laser, plasma or hot air.

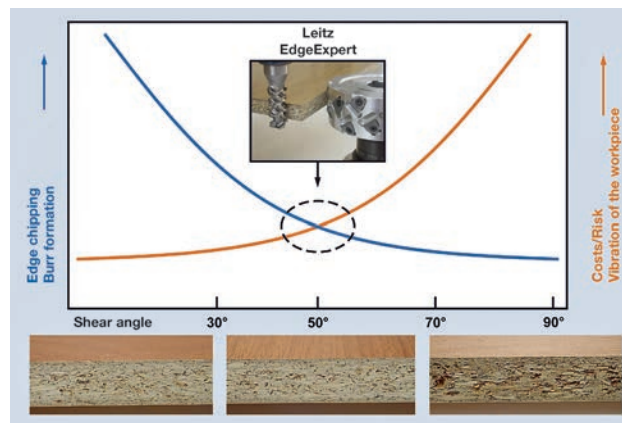

Dust collection

The tool characteristics of the joint cutter Diamaster PRO low noise model range have DFC gullet for delayed chip ejection and are suitable for i-system.

Chip removal

The chip removal has an important influence on the machining quality and on the tool life. Through a reduction of the chip removal, the arched length of the tool positioned in the interference is decreased, causing the tool to cut less material and to increase the tool life.

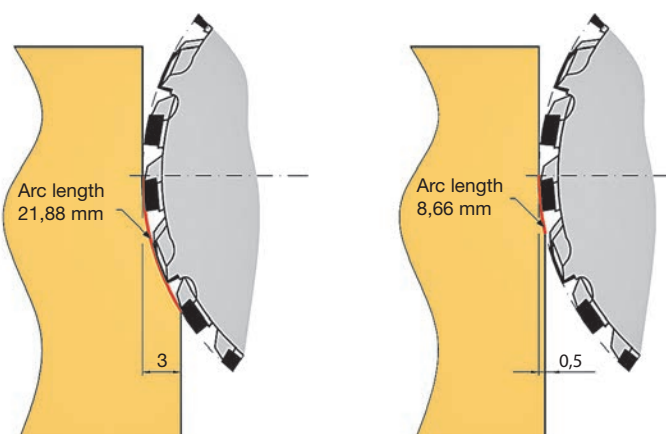

2. Panel processing

2.1 Edge processing

2.1.2 Jointing cutters

Noise emission

For noise reduction, LowNoise tools Diamaster PRO with its low knife protrusion, staggered edge and shear can be used. See section Edge Processing - Jointing Cutters.

Service

The Diamaster WhisperCut knives either can be serviced by Leitz Service or by the user on site.

Resharpener Diamaster WhisperCut



WhisperCut: Diamond knives are resharpenable in the tool body up to 3 times
WhisperCut PLUS: Diamond knives are resharpenable in the tool body up to 10 times

Diamaster WhisperCut – The jointing cutterhead with exchan- geable knives

- constant diameter
- quick and easy knife change by the user on site
- no costly adjustment at the machine
- no interchangeable tool required
- optimal knife utilization with small material thicknesses

Feed speed related to RPM and number of teeth Z

Material: Chipboard with melamine
resin coating

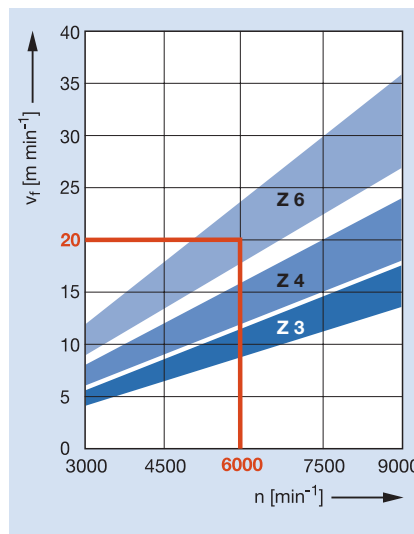



WhisperCut jointing / milling cutter - cutterhead design

Application:

For tear-free and low noise jointing of workpiece edges side with and against feed (jump cutting).

Machine:

Edgebanding machines, copy shaping machines, double-end tenoners etc.

Workpiece material:

Chip and fibre board (MDF etc.) uncoated, veneered, plastic and paper coated, fibre reinforced plastics (GFRP, CFRP etc.).

Technical information:

DP tipped cutterhead with alternate shear angle for tear-free jointing edges and cutting surfaces. Tool with knife arrangement S can be used left and right and produces hollow cut for tightly closing edgebanding. Low noise design with up to 5 dB(A) noise reduction and highly efficient chip collection (>95%) by DFC. Significant weight reduction by using an aluminium alloy tool body. Carrier body for multiple use with exchangeable knives. 0.6 mm reshaping area.

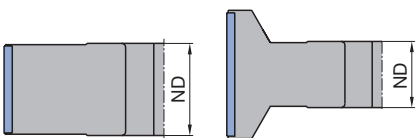
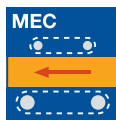

Position of boss (NAL) 1

Position of boss (NAL) 2

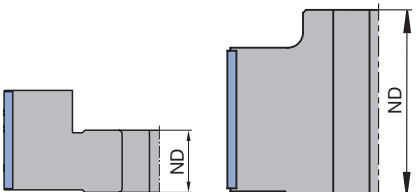

Position of boss (NAL) 3

Position of boss (NAL) 4

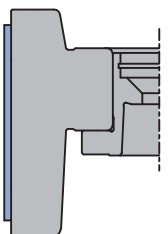

Position of boss (NAL) 5

Diamaster WhisperCut - DFC, LowNoise, aluminium alloy tool body

WF 230 2 DP, WM 230 2 01

Machine	D mm	SB mm	ND mm	BO mm		NAL	Z	Knife Type	Type	ID LH	ID RH
Ayza Mizrak	70	54	30	20	DKN	2	2x5	10xD	AS	192320 ●	192321 ●
Ayza Mizrak	125	54	40	30	DKN	3	3x5	15xE	AS	192326	192327
Biesse	80	45	53	30	DKN	1	2x4	8xB	S	192127 ●	192127 ●
Biesse	80	65	53	30	DKN	2	2x6	12xB	S	192128 ●	192128 ●
Biesse	100	43	75	30	DKN	1	3x4	12xA	S	192088 ●	192088 ●
Biesse	100	65	75	30	DKN	1	3x6	18xA	S	192089 ●	192089 ●
Biesse	125	43	40	30	DKN	2	3x4	12xE	S	075627 ●	075627 ●
Biesse	125	63	40	30	DKN	2	3x6	18xE	S	075626 ●	075626 ●
Brandt	100	43.6	40.6	25	DKN	3	2x4	8xA	AS	192211 ●	192212 ●
Brandt	100	62.5	40.6	25	DKN	3	2x6	12xA	AS	192345	192346
Brandt	100	43.6	40.6	30	DKN	3	3x4	12xA	AS	090885 ●	090886 ●
Brandt	100	65.2	40.6	30	DKN	3	3x6	18xA	AS	090887 ●	090888 ●
Brandt	100	85	85	30	DKN	3	3x8	24xA	AS	090889	090890
Brandt	100	105	85	30	DKN	3	3x10	30xA	AS	090891	090892
Cehisa	100	54	25	20	DKN	2	2x5	10xA	AS	192078 ●	192079 ●
EBM	70	43	61	25	DKN	4	2x4	8xB	AS	192237 ●	192238 ●
EBM	70	63	81	25	DKN	4	2X6	12xB	AS	192239 ●	192240 ●
EBM	100	43	61	30	DKN	4	2x4	8xB	AS	192233 ●	192234 ●
EBM	100	63	81	30	DKN	4	2x6	12xB	AS	192235 ●	192236 ●
Felder	60	63	63.5	25	DKN	3	2x7	12xC	AS°		192278 ●
Felder	60	63	63.5	25	DKN	3	2x7	12xC	AS°	192277 ●	
Felder	80	48.5	64	25	DKN	4	3x6	12xF	AS°	192281 ●	192282 ●
Felder	80	64	64	25	DKN	3	2x7	12xF	AS°		192300 ●
Felder	80	64	64	25	DKN	3	2x7	12xF	AS°	192299 ●	
Felder	80	64	64	25	DKN	3	3x7	18xF	AS°	192279 ●	
Felder	80	64	64	25	DKN	3	3x7	18xF	AS°		192280 ●
Fravol	60	63	63.5	25	DKN	3	2x7	12xC	AS°	192247 ●	
Fravol	60	63	63.5	25	DKN	3	2x7	12xC	AS°		192248 ●
Fravol	60	84	61	25	DKN	3	2x8	14xC	AS°	192241 ●	
Fravol	60	84	61	25	DKN	3	2x8	14xC	AS°		192242 ●

● available ex stock

□ available at short notice

Instruction manual visit www.leitz.org

2. Panel processing

2.1 Edge processing

2.1.2 Jointing cutters

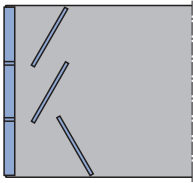

Type AS = asymmetric tip arrangement

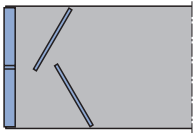

Type S = symmetric tip arrangement

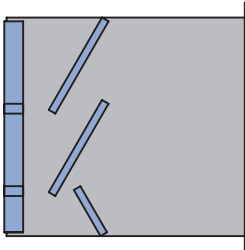

Type AS° = asymmetric tip arrangement with a narrow row of teeth below

Machine	D	SB	ND	BO		NAL	Z	Knife	Type	ID	ID
	mm	mm	mm	mm				Type		LH	RH
Fraval	100	65	56.5	30	DKN	3	2x6	12xA	AS	192243 ●	192244 ●
Fraval	100	84	56.5	30	DKN	3	2x8	14xA	AS°	192285 ●	
								14xA1			
Fraval	100	84	56.5	30	DKN	3	2x8	14xA	AS°		192286 ●
								14xA2			
Fraval	100	124	96	30	DKN	2	2x11	22xA	AS	192245	192246
Hebrock	70	43	61	25	DKN	4	2x4	8xB	AS	192237 ●	192238 ●
Hebrock	70	63	81	25	DKN	4	2X6	12xB	AS	192239 ●	192240 ●
Hebrock	100	43	61	30	DKN	4	2x4	8xB	AS	192233 ●	192234 ●
Hebrock	100	63	81	30	DKN	4	2x6	12xB	AS	192235 ●	192236 ●
Holz-Her	70	48	41	30	DKN	2	2x5	8xD	AS°		192221 ●
								2xD2			
Holz-Her	70	48	41	30	DKN	2	2x5	8xD	AS°	192222 ●	
								2xD1			
Holz-Her	70	64	41	30	DKN	2	2x7	12xD	AS°		192223 ●
								2xD2			
Holz-Her	70	64	41	30	DKN	2	2x7	12xD	AS°	192224 ●	
								2xD1			
Holz-Her	100	63	39.5	30	DKN	2	3x6	18xB	S	192147 ●	192148 ●
								1804			
Holz-Her	100	43	25	30	DKN	2	2x4	8xA	AS	192082 ●	192083 ●
								1891			
Holz-Her	100	65	25	30	DKN	2	2x6	12xA	AS	192084 ●	192085 ●
								1891			
Holz-Her	100	63	39.5	HSK 32	R 5	3x6	18xB	S	192307 ●	192308 ●	
								FG701			
Homag	100	43.6	40.6	25	DKN	3	2x4	8xA	AS	192211 ●	192212 ●
Homag	100	62.5	40.6	25	DKN	3	2x6	12xA	AS	192345	192346
Homag	100	43.6	40.6	30	DKN	3	3x4	12xA	AS	090885 ●	090886 ●
Homag	100	65.2	40.6	30	DKN	3	3x6	18xA	AS	090887 ●	090888 ●
Homag	100	85	85	30	DKN	3	3x8	24xA	AS	090889	090890
Homag	100	105	85	30	DKN	3	3x10	30xA	AS	090891	090892
Homag	125	42.6	54	30	DKN	3	3x4	12xA	AS	192287 ●	192288 ●
Homag	125	43	40	30	DKN	2	3x4	12xE	S	075627 ●	075627 ●
Homag	125	63	40	30	DKN	2	3x6	18xE	S	075626 ●	075626 ●
Homag	125	64.4	54	30	DKN	3	3x6	18xA	AS	192289	192290
IMA	125	32	34	30	DKN	2	3x4	12xD	AS	192092 ●	192093 ●
IMA	125	43	42	30	DKN	2	3x5	15xD	AS	192094 ●	192095 ●
IMA	125	63	42	30	DKN	3	3x7	21xD	AS	192096 ●	192097 ●
IMA	125	43	57	30	DKN	4	3x5	15xD	AS	192098 ●	192099 ●
Advantage											
IMA	125	65	57	30	DKN	4	3x7	21xD	AS	192100 ●	192101 ●
Advantage											
Mizrak Ma-	70	54	30	20	DKN	2	2x5	10xD	AS	192320 ●	192321 ●
chine											
Ott	85	48	50	30	DKN	3	3x5	12xB	AS°	192209 ●	
								3xB1			
Ott	85	48	50	30	DKN	3	3x5	12xB	AS°		192210 ●
								3xB2			
Ott	85	65	45	30	DKN	2	3x6	18xB	AS	192227 ●	192228 ●
Ott	85	85	50	30	DKN	3	3x8	24xB	AS	192229 ●	192230 ●
SCM	100	51	60	30	DKN	3	2x6	8xB	AS°	192215 ●	192216 ●
								2xB1			
								2xB2			
SCM	100	51	60	30	DKN	3	3x6	12xB	AS°	192217 ●	192218 ●
								3xB1			
								3xB2			
SCM	100	66	60	30	DKN	3	2x7	12xB	AS°	192213 ●	
								2xB1			
SCM	100	66	60	30	DKN	3	2x7	12xB	AS°		192214 ●
								2xB2			
SCM	100	66	60	30	DKN	3	3x7	18xB	AS°	192219 ●	
								3xB1			
SCM	100	66	60	30	DKN	3	3x7	18xB	AS°		192220 ●
								3xB2			

2. Panel processing

2.1 Edge processing

2.1.2 Jointing cutters

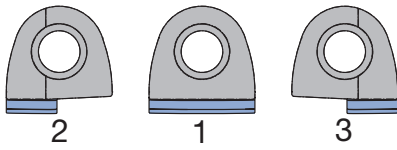

Shape of WhisperCut spare knives
SB 6.7 / 14 mm

Machine	D mm	SB mm	ND mm	BO mm	NAL	Z	Knife Type	Type	ID LH	ID RH
SCM	125	51		HSK 32	R 5	3x6	12xA 3xA1 3xA2	AS°	192337	192338
SCM	125	51		HSK 32	R 5	4x6	16xA 4xA1 4xA2	AS°	192341	192342
SCM	125	66		HSK 32	R 5	3x7	18xA 3xA1	AS°	192339	
SCM	125	66		HSK 32	R 5	3x7	18xA 3xA2	AS°		192340
SCM	125	66		HSK 32	R 5	4x7	24xA 4xA1	AS°	192343	
SCM	125	66		HSK 32	R 5	4x7	24xA 4xA2	AS°		192344
Stefani	100	51	60	30 DKN	3	2x6	8xB 2xB1 2xB2	AS°	192215 ●	192216 ●
Stefani	100	51	60	30 DKN	3	3x6	12xB 3xB1 3xB2	AS°	192217 ●	192218 ●
Stefani	100	66	60	30 DKN	3	2x7	12xB 2xB1	AS°	192213 ●	
Stefani	100	66	60	30 DKN	3	2x7	12xB 2xB2	AS°		192214 ●
Stefani	100	66	60	30 DKN	3	3x7	18xB 3xB1	AS°	192219 ●	
Stefani	100	66	60	30 DKN	3	3x7	18xB 3xB2	AS°		192220 ●
Turanlar Makine	70	54	30	20 DKN	2	2x5	10xD	AS	192320 ●	192321 ●
Turanlar Makine	70	54	30	20 DKN	2	3x5	15xD	AS	192324	192325
Turanlar Makine	125	54	30	30 DKN	3	3x5	15xE	AS	192322 ●	192323 ●
Törk Makine	100	65.2	40.6	30 DKN	3	3x6	18xA	AS	090887 ●	090888 ●

Spare knives:

BEZ	ABM mm	QAL	Type	Shape	ID
WhisperCut-knife SB14	14x14.2x4.3	DP	A	1	091052 ●
WhisperCut-knife SB6.7	6.7x14.2x4.3	DP	A1	3	091082 ●
WhisperCut-knife SB6.7	6.7x14.2x4.3	DP	A2	2	091081 ●
WhisperCut-knife SB14	14x14.2x4.3	DP	B	1	091066 ●
WhisperCut-knife SB6.7	6.7x14.2x4.3	DP	B1	3	091067 ●
WhisperCut-knife SB6.7	6.7x14.2x4.3	DP	B2	2	091068 ●
WhisperCut-knife SB14	14x14.2x4.3	DP	C	1	091077 ●
WhisperCut-knife SB6.7	6.7x14.2x4.3	DP	C1	3	091079 ●
WhisperCut-knife SB6.7	6.7x14.2x4.3	DP	C2	2	091078 ●
WhisperCut-knife SB14	14x14.2x4.3	DP	D	1	091071 ●
WhisperCut-knife SB6.7	6.7x14.2x4.3	DP	D1	3	091073 ●
WhisperCut-knife SB6.7	6.7x14.2x4.3	DP	D2	2	091072 ●
WhisperCut-knife SB14	14x14.2x4.3	DP	E	1	091074 ●
WhisperCut-knife SB14	14x14.2x4.3	DP	F	1	091084 ●

Eroded spare knives for quick and easy knife change.

Spare parts:

BEZ	ABM mm	Machine	ID
Securing part set	40/30x8 M12	Holz-Her 1801/1802	116011 ●
Spindle nut	38x28 M25x1,5	Felder, Fraval	066566 ●
Countersink screw, Torx® 20/59°	M5x11.5		007899 ●
Spanner wrench	50x5	Holz-Her up to YOM 2016	117538 ●



WhisperCut EdgeExpert jointing / milling cutter - cutterhead design

Application:

For tear-free and noise reduced jointing of workpiece cutting surfaces with and against feed (jump cutting) particularly for sensitive decorative papers, foil coatings and veneers.

Machine:

Edgebanding machines, copy shaping machines, double-end tenoners etc.

Workpiece material:

Chip and fibre boards (MDF etc.) raw, veneered, painted and coated; especially for plastic, paper, HPL and anti-fingerprint coatings. Also suitable for surfaces in mat, high gloss or with relief structures.

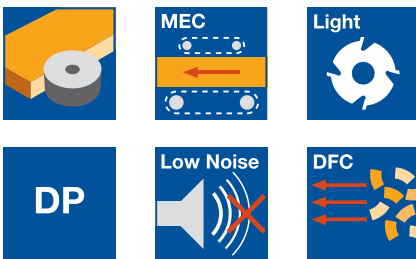

Technical information:

DP tipped cutterhead with alternate shear angle for tear-free jointing edges and cutting surface. Increased shear angle for excellent edge quality on sensitive decorative papers, foil coatings and veneers. Tool with knife arrangement S can be used lefthand and righthand and produces a hollow cut for tightly fitting edgebanding. Noise reduced design with up to 5 dB(A) noise reduction and highly efficient chip collection (>95%) through DFC. Significant weight reduction by using an aluminium alloy tool body. Carrier body for multiple use with exchangeable knives. 0.6 mm resharpening area.

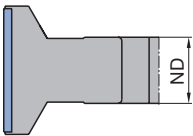

Position of boss (NAL) 2

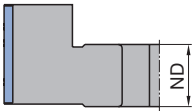

Position of boss (NAL) 3

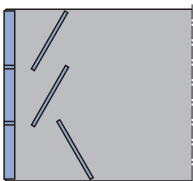

Type AS = asymmetric tip arrangement

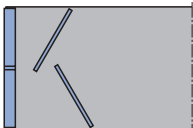

Type S = symmetric tip arrangement

Diamaster WhisperCut EdgeExpert - DFC, LowNoise, aluminium alloy tool body WM 230 2 01

Machine	D	SB	ND	BO	NAL	n_{max}	Z	Type	ID	ID
	mm	mm	mm	mm		min^{-1}			LH	RH
Biesse	125	43	40	30 DKN	2	13,700	3x6	S	192249 ●	192249 ●
Biesse	125	63	40	30 DKN	2	13,700	3x8	S	192250 ●	192250 ●
Homag	125	43	40	30 DKN	2	13,700	3x6	S	192249 ●	192249 ●
IMA	125	43	40	30 DKN	2	13,700	3x6	AS	192251 ●	192252 ●
IMA	125	63	40	30 DKN	3	13,700	3x8	AS	192301 ●	192302 ●



WhisperCut PLUS EdgeExpert jointing / milling cutter - cutterhead design

Application:

For tear-free and noise reduced jointing of workpiece cutting surfaces with and against feed (jump cutting) particularly for sensitive decorative papers, foil coatings and veneers.

Machine:

Edgebanding machines, copy shaping machines, double-end tenoners etc.

Workpiece material:

Chip and fibre boards (MDF etc.) raw, veneered, painted and coated; especially for plastic, paper, HPL and anti-fingerprint coatings. Also suitable for surfaces in mat, high gloss or with relief structures.

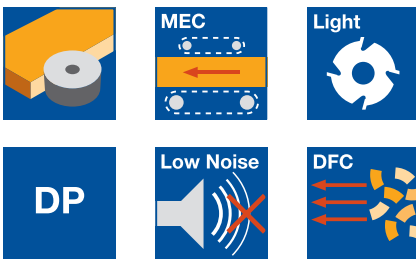

Technical information:

DP tipped cutterhead with alternate shear angle for tear-free jointing edges and cutting surface. Increased shear angle for excellent edge quality on sensitive decorative papers, foil coatings and veneers. Tool with knife arrangement S can be used lefthand and righthand and produces a hollow cut for tightly fitting edgebanding. Noise reduced design with up to 5 dB(A) noise reduction and highly efficient chip collection (>95%) through DFC. Significant weight reduction by using an aluminium alloy tool body. Carrier body for multiple use with exchangeable knives. 3.1 mm resharpening area.

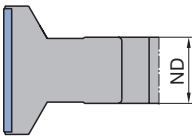

Position of boss (NAL) 2

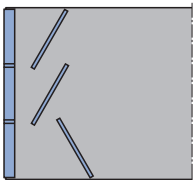

Type AS = asymmetric tip arrangement

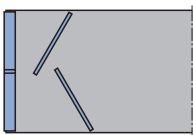

Type S = symmetric tip arrangement

Diamaster WhisperCut PLUS EdgeExpert - DFC, LowNoise, aluminium alloy tool body

WM 230 2 02

Machine	D mm	SB mm	ND mm	BO mm	NAL	n_{max} min ⁻¹	Z	Type	ID	
									LH	RH
Biesse	125	43	40	30	DKN 2	13,700	3x6	S	192255 ●	192255 ●
Homag	125	43	40	30	DKN 2	13,700	3x6	S	192255 ●	192255 ●
IMA	125	43	40	30	DKN 2	13,700	3x6	AS	192256 ●	192257 ●

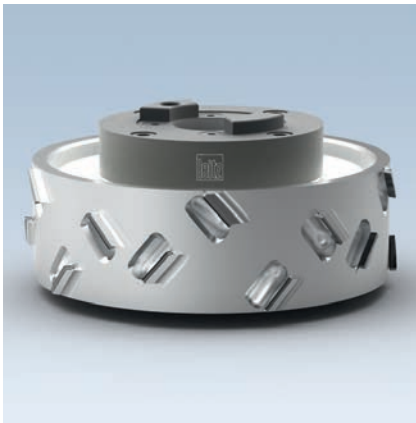

Jointing / milling cutter on hydro sleeve

Application:

For tear-free and low noise jointing of workpiece edges side with and against feed (jump cutting).

Machine:

Edgebanding machines with zero joint technology.

Workpiece material:

Chip and fibre board (MDF etc.) uncoated, veneered, plastic and paper coated, fibre reinforced plastics (GFRP, CFRP etc.).

Technical information:

Increase of the processing quality through zero clearance hydro adaptor. Tool with alternate shear angle for tear-free jointing edge and straight cutting surface. Low noise design with noise reduction up to 5 dB(A) and highly efficient chip collection (>95%). Tool with knife arrangement S produces hollow cut for tightly closing edgebanding.

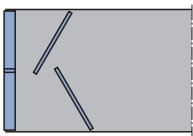
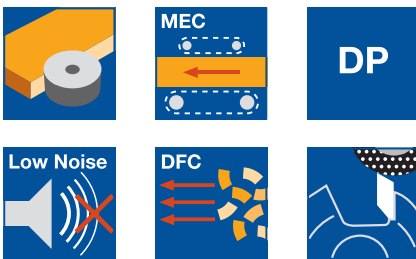

Type S = symmetric knife arrangement

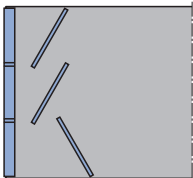

Type AS = asymmetric tip arrangement

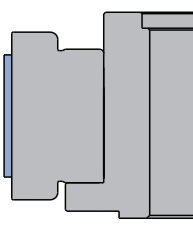

Position of boss (NAL) 1

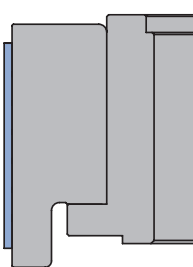

Position of boss (NAL) 2

Diamaster PRO mounted on hydro sleeve

HF 230 2, HF 230 2 DP

Machine	D mm	SB mm	BO mm	n_{max} min ⁻¹	NAL	Z	Type	ID	
								LH	RH
Homag	125	43	30	13,600	1	5x4	S	192133 □	192134 □
Homag	125	63	30	13,600	1	5x6	S	192135 □	192136 □
Homag	150	43	30	13,600	1	5x4	S	192205 □	192206 □
Homag	150	63	30	13,600	1	5x6	S	192207 □	192208 □

Diamaster WhisperCut EdgeExpert mounted on hydro sleeve

HM 230 2 01

Machine	D mm	SB mm	BO mm	n_{max} min ⁻¹	NAL	Z	Type	ID	
								LH	RH
IMA	125	43	30	13,700	1	4x6	AS	192259 □	192258 □
IMA	125	63	30	13,700	1	4x8	AS	192261 □	192260 □
IMA	150	43	30	13,700	1	4x6	AS	192263 □	192262 □
IMA	150	63	30	13,700	1	4x8	AS	192265 □	192264 □

Diamaster PRO mounted on hydro sleeve, IMA aggregate 08.379

WM 230 2 01

Machine	D mm	SB mm	BO mm	n_{max} min ⁻¹	NAL	Z	ID	
							LH	RH
IMA	125	65	30	13,700	2	4x7	192313 ●	192312 ●
IMA	125	43.5	30	13,700	2	4x5	192315 ●	192314 ●

Spare parts:

BEZ	ABM	ID
	mm	
Securing part	for HF-spindle HF 30	066563 ●
Allen key	SW 5, L 150	005501 ●

2. Panel processing

2.1 Edge processing

2.1.2 Jointing cutters

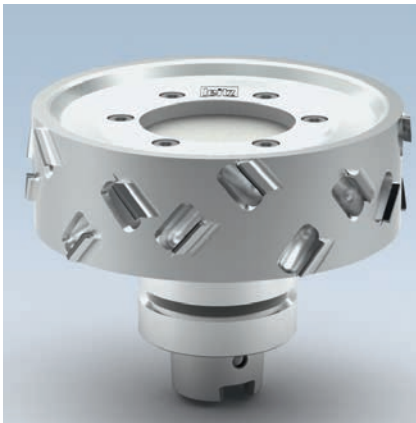

Jointing / milling cutter on HSK-F 63 arbor

Application:

For low noise jointing of workpiece edges with and against feed (jump cutting).

Machine:

Edgebanding machines with zero joint technology.

Workpiece material:

Chip and fibre board (MDF etc.) uncoated, veneered, plastic and paper coated, fibre reinforced plastics (GFRP, CFRP etc.).

Technical information:

Increase of the processing quality through zero clearance HSK adaptor. Composite tool with alternate shear angle for tear-free jointing edge and straight cutting surface. Low noise design with noise reduction up to 5 dB(A) and highly efficient chip collection (>95%). Tool with knife arrangement S produces hollow cut for tightly closing edgebanding. 1.5 mm resharpening area.

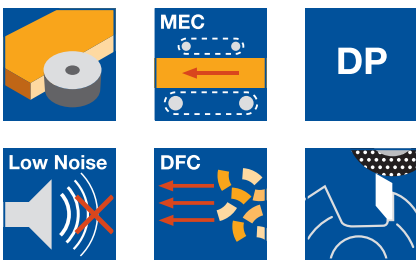

Diamaster PRO mounted on HSK-F 63 mod.

WF 230 2 DP

Machine	D mm	SB mm	BO mm	n_{max} min ⁻¹	Z	Type	ID LH	ID RH
Homag	150	43	HSK-F 63 mod.	13600	5x4	S	192197 □	192198 □
Homag	150	63	HSK-F 63 mod.	13600	5x6	S	192199 □	192200 □

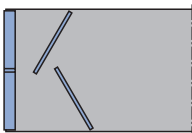

Type S = symmetric knife arrangement

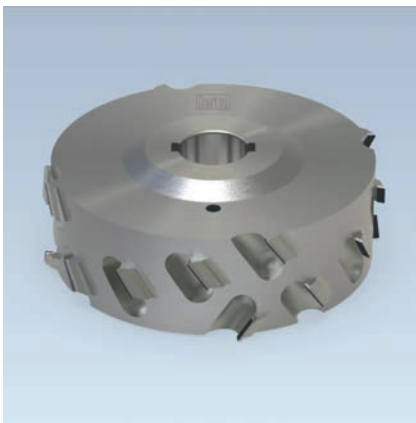

Jointing / milling cutter

Application:

For jointing/milling rebates in panel edges.

Machine:

Edgebanding machines and double-end tenoners.

Workpiece material:

Chip and fibre boards (MDF etc.) uncoated, veneered, plastic and paper coated.

Technical information:

Composite tool with alternate shear angle for tear-free edges. DFC design for chip flow and efficient chip clearance (>95%). 1.5 mm resharpening area.

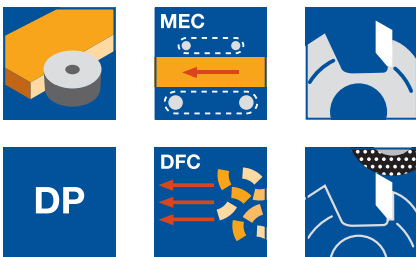

Diamaster PRO - DFC

WF 230 2 DP

D	SB	ND	BO	n_{max}	Z	ID	ID
mm	mm	mm	mm	min ⁻¹		LH	RH
150	45	39	30 DKN	11400	4x5	192266	192267
150	64	39	30 DKN	11400	4x7	192268	192269

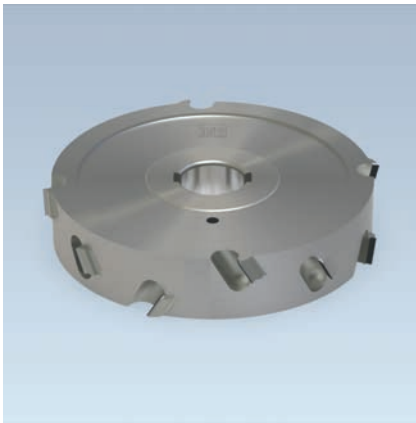

Protection milling / jump cutting

Application:

For tear-free jointing with and against feed (e.g. jump cutting).

Machine:

Edgebanding machines and double-end tenoners.

Workpiece material:

Chip and fibre board (MDF etc.) uncoated, veneered, plastic and paper coated, fibre reinforced plastics (GFRP, CFRP etc.).

Technical information:

Tool with alternate shear angle for tear-free edges and jointed edge. Low noise design with noise reduction of up to 5 dB(A) and efficient chip clearance (>95%). 1.5 mm resharpening area.

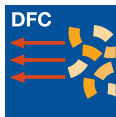
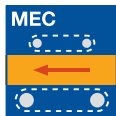

Diamaster PRO - DFC, LowNoise

WF 230 2 DP

Machine	D mm	SB mm	ND mm	BO mm	NAL	n_{max} min ⁻¹	Z	Type	ID	ID
									LH	RH
Homag, IMA	180	32	42	35 DKN	1	9,500	4x3	AS	090851	090852
Homag, IMA	180	43	46	35 DKN	1	9,500	4x4	AS	090841 ●	090842 ●
Homag, IMA	180	63	46	35 DKN	3	9,500	4x6	AS	090839 ●	090840 ●

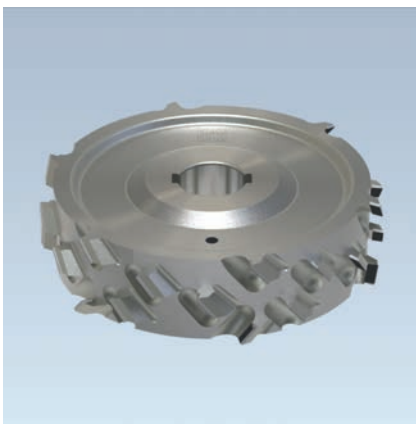

Protection milling / jump cutting

Application:

For tear-free jointing with and against feed (e.g. jump cutting).

Machine:

Edgebanding machines and double-end tenoners.

Workpiece material:

Chip and fibre board (MDF etc.) uncoated, veneered, plastic and paper coated, fibre reinforced plastics (GFRP, CFRP etc.).

Technical information:

Tool with large, alternate shear angle for tear-free edges and straight jointed edge. 4.0 mm resharpening area.

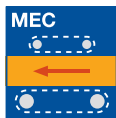

Diamaster PLUS

WF 230 2

Machine	D mm	SB mm	ND mm	BO mm	NAL	n_{max} min ⁻¹	Z	Type	ID	ID
									LH	RH
Homag, IMA	180	34	34	35 DKN	2	9500	6x3	AS	090847	090848
Homag, IMA	180	43	46	35 DKN	1	9500	6x5	AS	192056	192057
Homag, IMA	180	63	46	35 DKN	3	9500	6x7	AS	192058	192059
Homag, IMA	180	34	34	35 DKN	2	9500	8x4	AS	192060	192061
Homag, IMA	180	43	46	35 DKN	1	9500	8x5	AS	192062	192063
Homag, IMA	180	63	46	35 DKN	3	9500	8x7	AS	192064	192065

Recommended feed rate for 6000 min⁻¹ for veneered or coated particle and fibre materials.

Z=4	25 m min ⁻¹
Z=6	35 m min ⁻¹
Z=8	45 m min ⁻¹
Z=10	55 m min ⁻¹
Z=12	65 m min ⁻¹
Z=14	80 m min ⁻¹

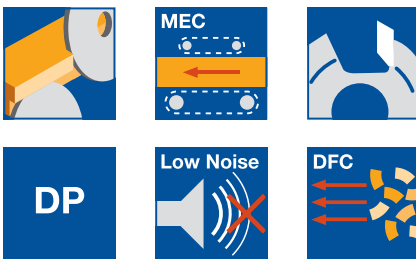

Diamaster DT Premium

Application:

For hogging along and across grain - sizing - especially for **hogging / hogging**.

Machine:

Double-end tenoners, edgebanding machines etc.

Workpiece material:

Chip and fibre board (MDF etc.) uncoated, veneered, plastic and paper coated, light construction panels (honeycomb).

Technical information:

Maximum economic efficiency through long tool life even in different materials (batch size 1). Up to 15 times resharpenable and constant cutting width over the entire life cycle. Perfect edge quality and smooth cutting surfaces through adapted cutting geometries. Clean workpiece finishes due to efficient chip removal with DFC-technology. Hogger as standard with 4 pinholes reference diameter 100 and quick clamping system 160 (BO 60) and 192 (BO 80).

Diamaster DT Premium

HZ 210 2

D	SB	BO	ZF	Z	v_f^*	ID	ID
mm	mm	mm			m min ⁻¹	LH	RH
250	10	60	1	24	30	190382	190383
250	10	60	1	30	35	190386	190387
250	10	60	1	36	40	190390	190391
250	10	60	1	42	45	190394	190395
250	10	60	1	48	50	190398	190399
250	10	60	1	54	60	190402	190403
250	10	60	1	60	80	190406	190407
250	10	60	2	24	30	190384	190385
250	10	60	2	30	35	190388	190389
250	10	60	2	36	40	190392	190393
250	10	60	2	42	45	190396	190397
250	10	60	2	48	50	190400	190401
250	10	60	2	54	60	190404	190405
250	10	60	2	60	80	190408	190409
250	10	80	1	24	30	190410	190411
250	10	80	1	30	35	190414	190415
250	10	80	1	36	40	190418	190419
250	10	80	1	42	45	190422	190423
250	10	80	1	48	50	190426	190427
250	10	80	1	54	60	190430	190431
250	10	80	1	60	80	190434	190435
250	10	80	2	24	30	190412	190413
250	10	80	2	30	35	190416	190417
250	10	80	2	36	40	190420	190421
250	10	80	2	42	45	190424	190425
250	10	80	2	48	50	190428	190429
250	10	80	2	54	60	190432	190433
250	10	80	2	60	80	190436	190437

Order example:

Hogging set D-250 mm, Z 36, right
Hogging set consisting of:
DT Premium hogger D-250 ID **190391**
Hydro clamping sleeve ID **061702**

Special information:

Including assembly, machine model

Tooth shape 1 (ZF 1):

For processing different materials (batch size 1), coated wood materials such as HPL, melamine, high gloss.

Tooth shape 2 (ZF 2):

For processing veneers, paper, honeycomb panels.

Further dimensions on request.

Standard flanged sleeves, hydro clamping elements, quick clamping and hydro quick clamping sleeves, see section Clamping Systems.

* Recommended feed rate.

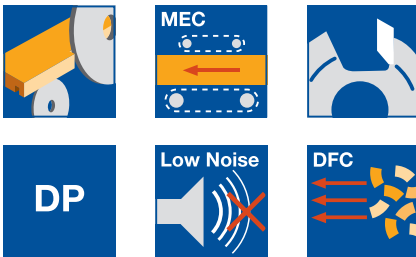

Order example:

Hogging set D-250 mm, Z 36, right
 Hogging set consisting of:
 DT Premium Score hogger D-250
 ID **190443**
 Hydro clamping sleeve ID **061702**

Special information:

Including assembly, machine model

Tooth shape 1 (ZF 1):

For processing different materials (batch size 1), coated wood materials such as HPL, melamine, high gloss.

Tooth shape 2 (ZF 2):

For processing veneers, paper, honeycomb panels.

Diamaster DT Premium Score

Application:

For hogging along and across grain - sizing - especially for **scoring / hogging**.

Machine:

Double-end tenoners, edgebanding machines etc.

Workpiece material:

Chip and fibre board (MDF etc.) uncoated, veneered, plastic and paper coated, light construction panels (honeycomb).

Technical information:

Maximum economic efficiency through long tool life even in different materials (batch size 1). Up to 15 times resharpenable and constant cutting width over the entire life cycle. Perfect edge quality and smooth cutting surfaces through adapted cutting geometries. Clean workpiece finishes due to efficient chip removal with DFC-technology. Hogger as standard with 4 pinholes reference diameter 100 and quick clamping system 160 (BO 60) and 192 (BO 80).

Diamaster DT Premium Score

HZ 210 2

D	SB	BO	ZF	Z	v_f^*	ID	ID
mm	mm	mm			m min ⁻¹	LH	RH
250	10	60	1	24	18	190438	190439
250	10	60	1	36	25	190442	190443
250	10	60	1	48	30	190446	190447
250	10	60	1	60	40	190450	190451
250	10	60	2	24	18	190440	190441
250	10	60	2	36	25	190444	190445
250	10	60	2	48	30	190448	190449
250	10	60	2	60	40	190452	190453
250	10	80	1	24	18	190454	190455
250	10	80	1	36	25	190458	190459
250	10	80	1	48	30	190462	190463
250	10	80	1	60	40	190466	190467
250	10	80	2	24	18	190456	190457
250	10	80	2	36	25	190460	190461
250	10	80	2	48	30	190464	190465
250	10	80	2	60	40	190468	190469

Further dimensions and version with veneer cutting edges (FUZ) on request.

Standard flanged sleeves, hydro clamping elements, quick clamping and hydro quick clamping sleeves, see section Clamping Systems.

* Recommended feed rate.

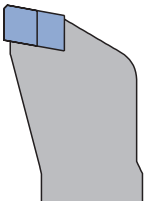
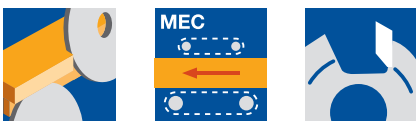

Tooth with decreasing bevel for higher cutting performance, particularly suitable for material with a loose middle layer.

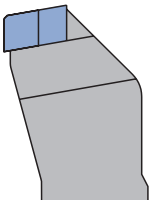

Tooth with increasing bevel for maximum stability, particularly suitable for materials with high mineral content and boards with large material overhang. At decreasing bevel and low overlap remain strips, which won't be hogged.

Compact hogger

Application:

For hogging along and across grain - for sizing applications in double hogging process (**hogging / hogging**).

Machine:

Double-end tenoners, edgebanding machines etc.

Workpiece material:

Particle and fibre materials (MDF etc.) uncoated, veneered, plastic and paper coated, lightweight panels (honeycomb).

Technical information:

Resharpenable 10 times. **Tooth with decreasing bevel** for higher cutting performance, particularly suitable for materials with a loose middle layer.

Tooth with increasing bevel for maximum stability, particularly suitable for materials with high mineral content and boards with a large material overhang. Hogger as standard with 4 pinholes reference diameter 100 and quick clamping system 160 (BO 60) and 192 (BO 80).

Compact hogger

HZ 210 2

D	SB	BO	Z	ZF	v_f^*	ID	ID
mm	mm	mm			$m \text{ min}^{-1}$	LH	RH
250	10	60	35	decreasing	35	190358 ●	190359 ●
250	10	60	45	decreasing	45	190360 ●	190361 ●
250	10	60	55	decreasing	55	190362	190363
253	10	60	35	increasing	35	190364	190365
253	10	60	45	increasing	45	190366	190367
253	10	60	55	increasing	55	190368	190369
250	10	80	35	decreasing	35	190370	190371
250	10	80	45	decreasing	45	190372	190373
250	10	80	55	decreasing	55	190374	190375
253	10	80	35	increasing	35	190376	190377
253	10	80	45	increasing	45	190378	190379
253	10	80	55	increasing	55	190380	190381

Standard flanged sleeves, hydro clamping, quick clamping and hydro quick clamping sleeves, see Lexicon section Clamping Systems.

* Recommended feed rate for coated chipboard materials and fibre materials.

2. Panel processing

2.1 Edge processing 2.1.4 Cutting and segment hoggers

Process	Hogging along and across grain with/without scoring sawblades.
Workpiece materials	Solid wood, wood derived materials and composite materials.
Machines	Multi-rip saws, double-end tenoners, window making machines, edgebanding machines.

Application

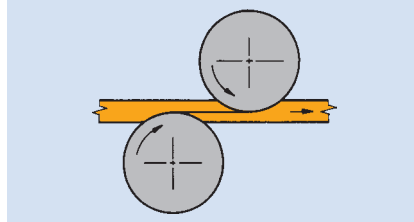

Double hogging:
Both hoggers cut with feed.

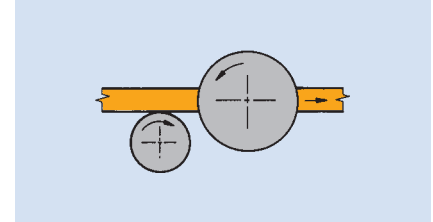

Scoring/hogging:
Scoring saw cuts with feed, hogger against feed.

Recommended tooth shape hogger sawblades

Workpiece material		FZ	ES	WZ
Softwood and hardwood	along grain	■		□
	across grain		■	■
Laminated wood	along grain	□	■	
	across grain		■	■
Chip/fibre materials	without coating	■	□	
	plastic coated	■	□	
	veneered		■	■
	paper coated		■	□
Composite material	HPL-coated	■	□	
	HDF, MDF veneered		■	□

- suitable
- partly suitable

Cutting width and RPM

Tool*	D/mm	SB/mm	RPM max.
Segment hogger	250	25 – 50	7200 m/min ⁻¹
	300	30 – 60	6000 m/min ⁻¹
	350	35 – 70	5100 m/min ⁻¹

* A larger sawblade diameter is recommended for veneered chipboard, fibre materials and laminated wood (e.g. hogger D 250 mm → recommended sawblade D 260 mm).

Segment hogger

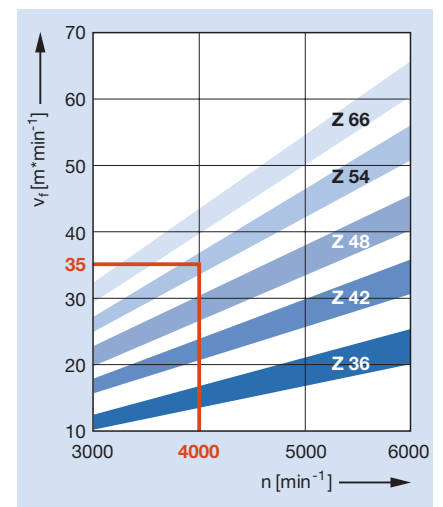
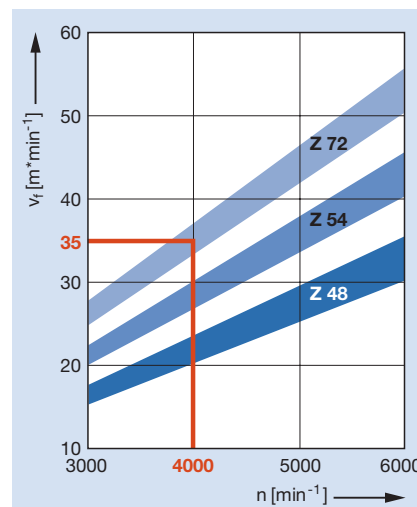

Feed speed v_f in relation to the number of teeth Z and RPM n .

2. Panel processing

2.1 Edge processing

2.1.4 Cutting and segment hoggers

Segment hogger

Segment hoggers are a modular design. Segment hoggers are used, depending on the diameter, for hogging widths from 25 to 70 mm. Hoggers or segment hoggers combined with different circular sawblades are suitable for cutting the following materials along and across the grain:

- Solid wood
- Wood derived materials without coating
- Wood derived materials with coating, with veneer, with paper etc.
- Composite materials

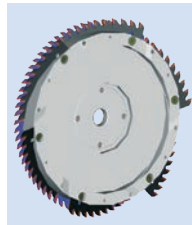

Cross cut

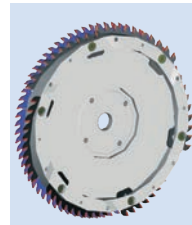

Length cut

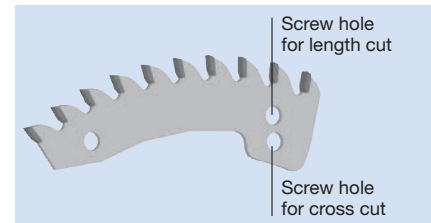

The hogging segments in segment hoggers are set either for length and or cross cut. The cross cut setting reduces the risk of breaking the corner of the workpiece when cross cutting against the feed.

Segment hoggers with up to 12 segments are used for edging and sizing on wood-derived material production lines (e.g. Siempelkamp, Kontra etc.). A special segment hogger design has been developed for the finish cut on wood derived material production lines.

Saw hogger

Saw hoggers, single tools or assemblies with cutting widths of 6.35 - 12.00 mm are used for hogging along and across the grain and to size solid wood on finger jointing machines.

Assembly design/examples

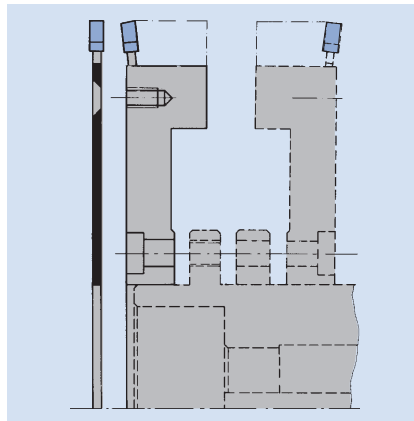

Segment hogger with extension hogger.



Hoggers

Application:

For tear-free sizing along and across grain. Machining against feed only combined with scoring sawblade. Defined trimming in front of the finger cut for adjusting the finger fit.

Machine:

Double-end tenoner, finger joint machine with trimming aggregate.

Workpiece material:

Solid wood and wood derived materials.

Technical information:

Steel tool body with HW circular sawblade and hogger elements mounted on flanged sleeve. Can be extended for larger hogger widths. Single sided bevel tooth shape reduces tear outs.



Basic hogger - steel tool body without flanged sleeve

WZ 210 2 01, WZ 210 2 02

BEZ	D	SB	BO	QAL	Z	ID	ID
	mm	mm	mm			LH	RH
Basic hogger	251	12	80	HW	18	062602 ●	062603 ●
Basic hogger	301	12	80	HW	24	062604 ●	062605 ●
Extension cutter	251	12	80	HW	18	062652 ●	062653 ●
Extension cutter	251	12	80	HW	24	062654 ●	062655 ●

Spare parts:

Part- no.	BEZ	ABM	BEM	ID
		mm		
1	Spacer	115x5x80		028046 ●
2	Cylindrical screw with ISK	M8x20		005946 ●
3	Countersink screw, Torx® 20	M6x10	Torx® 20	006083 ●
4	Screw with ISK	M8x17	for D = 250/350/305/355	006237 ●
5	Allen key	SW 6		005494 ●
6	Torx® key	Torx® 20		117503 ●

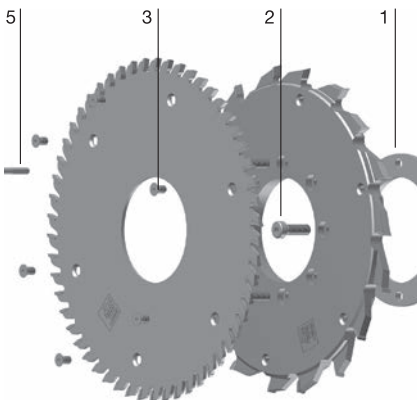

Application:

Tear-free sizing along and across the grain for working against the feed only with a scoring sawblade. Defined trimming in front of the finger cut for adjusting the finger fit.

Circular sawblade

WK 800 2 09, WK 800 2 38, WK 801 2, WK 801 2 05

D	SB	BO	Z	ZF	QAL	ID	ID
mm	mm	mm				LH	RH
250	4.4	80	54	FZ	HW	061825 ●	061826 ●
250	4.4	80	54	ES	HW	061837 ●	061838 ●
250	4.4	80	72	FZ	HW	061945 ●	061946 ●
260	4.4	80	72	ES	HW	061860	061861
260	4.4	80	72	FZ	HW	061947 ●	061948 ●
300	4.4	80	48	FZ	HW	061827 ●	061828 ●
300	4.4	80	48	ES	HW	062028	062029
300	4.4	80	72	FZ	HW	061949	061950

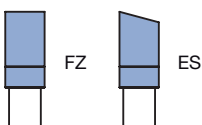

2. Panel processing

2.1 Edge processing

2.1.4 Cutting and segment hoggers



Segment hoggers

Application:

For tear-free sizing along and across grain. Machining against feed only combined with scoring sawblade. Defined trimming in front of the finger cut for adjusting the finger fit.

Machine:

Double-end tenoners, finger joint machine with trimming aggregate, plug cutter.

Workpiece material:

All types of solid wood, chip and fibre boards (MDF ect.) uncoated, veneered, plastic and paper coated.

Technical information:

Steel tool body with HW circular sawblade and segment hogging elements. Staggered cut through six hogger segments. Mounted on flanged sleeve. Can be extended for larger hogging width. Single sided bevel tooth shape to improve the cutting quality and to reduce tear outs.

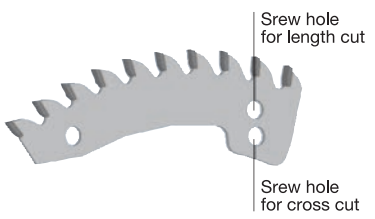
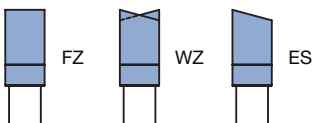
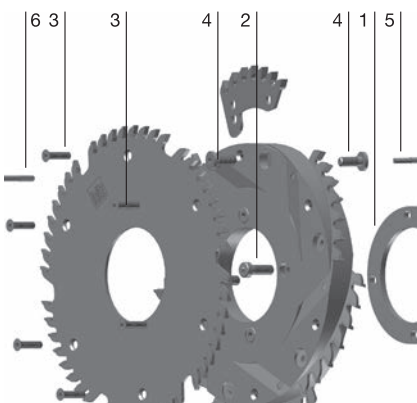
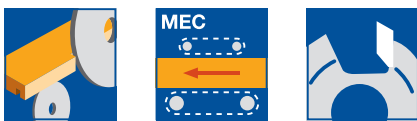

Spare segments for segment hogger

Steel basic and extension hoggers without flanged sleeve

WZ 300 2

D	SB	BO	Z	ZF	QAL	ID	ID
mm	mm	mm				LH	RH
250	26,0	80	6x7	FZ	HW	064410 ●	064411 ●
300	31.5	30	6x9	FZ	HW	064412 ●	064413 ●
350	36.5	30	6x10	FZ	HW	064414 ●	064415 ●

Spare parts:

Part- no.	BEZ	ABM	SB	QAL	ZF	Z	BEM	ID
		mm	mm					
	Hogging segment	D 250	5.7	HW	FZ	7		064958 ●
	Hogging segment	D 250	5.7	HW	FZ	7		064959 ●
	Hogging segment	D 300	5.7	HW	FZ	9		064960 ●
	Hogging segment	D 300	5.7	HW	FZ	9		064961 ●
	Hogging segment	D 350	5.7	HW	FZ	10		064962 ●
	Hogging segment	D 350	5.7	HW	FZ	10		064963 ●
1	Spacer	115x5x80						028046 ●
2	Cylindrical screw with ISK	M8x20						005946 ●
3	Countersink screw, Torx® 20	M6x10					Torx® 20	006083 ●
4	Screw with ISK	M8x17					for D = 250, 350, 305, 355	006237 ●
5	Allen key	SW 6						005494 ●
6	Torx® key	Torx® 20						117503 ●

Spare circular sawblade for segment hogging set

WK 800 2 45, WK 800 2 46, WK 801 2, WK 850 2 45

D	SB	BO	Z	ZF	QAL	ID	ID
mm	mm	mm				LH	RH
250	3.2	80	42	WZ	HW	058219	058220
250	4.4	80	48	FZ	HW	061831 ●	061832 ●
250	4.4	80	48	ES	HW	061878 ●	061879 ●
250	4.4	80	66	FZ	HW	061953 ●	061954 ●
260	4.4	80	48	ES	HW	061963	061964
260	4.4	80	66	ES	HW	061965 ●	061966 ●
300	4.4	30	42	FZ	HW	061833	061834
300	3.2	30	54	WZ	HW	058221 ●	058222 ●
300	4.4	30	66	FZ	HW	061055 ●	061056 ●
350	3.2	30	66	WZ	HW	058223 ●	058224 ●

2. Panel processing

2.1 Edge processing

2.1.4 Cutting and segment hoggers

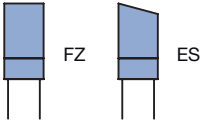
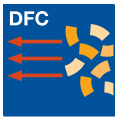

DFC segment hogger available on special request.

Spare circular sawblade for DFC segment hogger

WK 801 2, WK 801 2 05

D	SB	BO	Z	ZF	QAL	ID	ID
mm	mm	mm				LH	RH
250	4.4	80	54	ES	HW	061837 ●	061838 ●
260	4.4	80	54	ES	HW	061858	061859
260	4.4	80	72	ES	HW	061860	061861

Circular sawblades:

Tooth shape **ES** is optimised to cut across grain on softwood, hardwood, wood derived materials, veneered and paper coated and veneered composite materials.

Segments for DFC hogger (6 pieces / hogger)

TM 170 0

D	Z	ZF	QAL	ID	ID
mm				LH	RH
246	5	FZ	HW	064974 ●	064975 ●

DFC segment hogger available on special request.

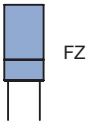

Circular sawblade for non-Leitz segment hoggers

WK 800 2 46

Type	D	SB	BO	Z	ZF	QAL	ID	ID
	mm	mm	mm				LH	RH
1	250	4	80	48	FZ	HW	061870 ●	061871 ●
1	250	4	100	48	FZ	HW	061872 □	061873 □

Type 1 for Leuco.

Segments for non-Leitz segment hogger

TM 170 0

Type	for D	SB	Z	ZF	QAL	ID	ID
	mm	mm				LH	RH
1	200/250	4	4	FZ	HW	064976 ●	064977 ●

Type 1 for Leuco.

2. Panel processing

2.1 Edge processing

2.1.5 Grooving cutters

Grooving with feed

Straight cut composite tool for grooving with feed (MEC).

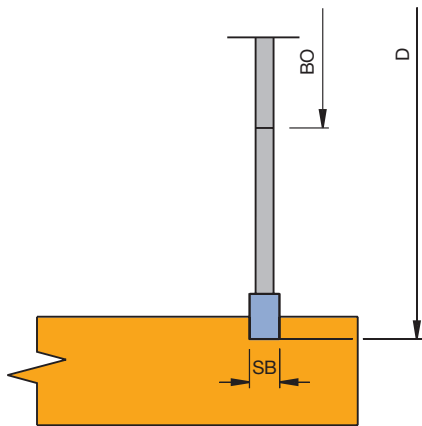

Cutting rear panel grooves

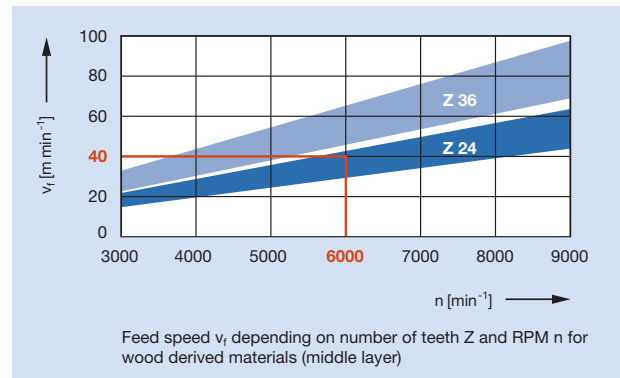
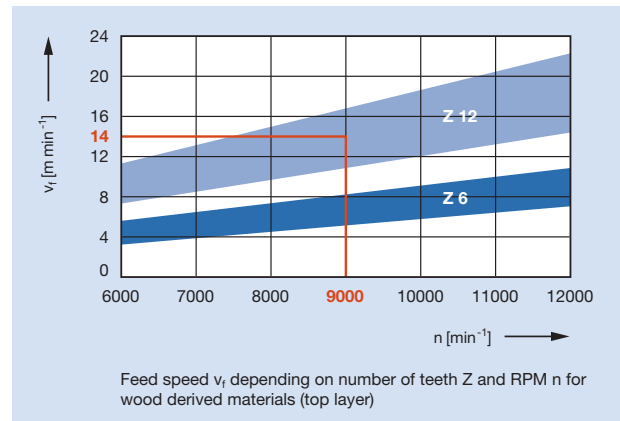

Grooving against feed

For tear-free cutting of different grooving widths on spindle moulders, moulders, edgebanding machines and double-end tenoners in uncoated and coated wood derived materials.

Adjustment of the cutting width with spacers (adjustment steps 0.1 mm). High chip collection by working against feed. Feed speed up to 40 m min⁻¹. Constant grooving width and distances to the machine chain also after regrinding. Special cutting geometry for tear-free cuts. Suitable to mount on sleeves with bore 30, 35 and 40 mm. Tipping height 6.0 mm.

Tools for grooving against feed available on request.

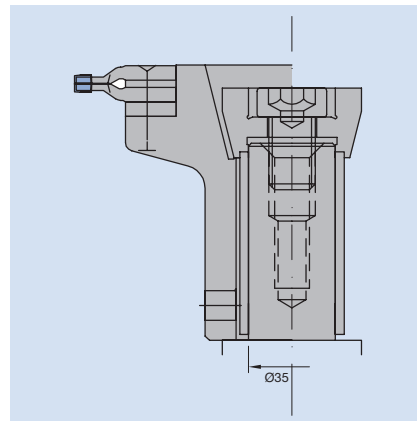

Assembly example:
Spindle 30 KN or DKN

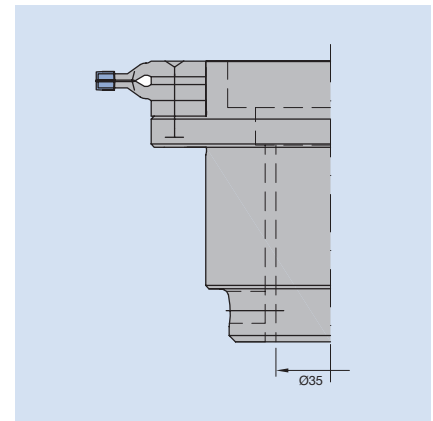

Assembly example:
Spindle 35 KN or DKN



Grooving cutter for mechanical feed

Application:

Grooving with feed (climb cut).

Machine:

Moulders and double-end tenoners.

Workpiece material:

Solid wood, uncoated, coated and veneered wood derived materials.

HW tipped

WF 100 2, WF 100 2 02, WF 100 2 03

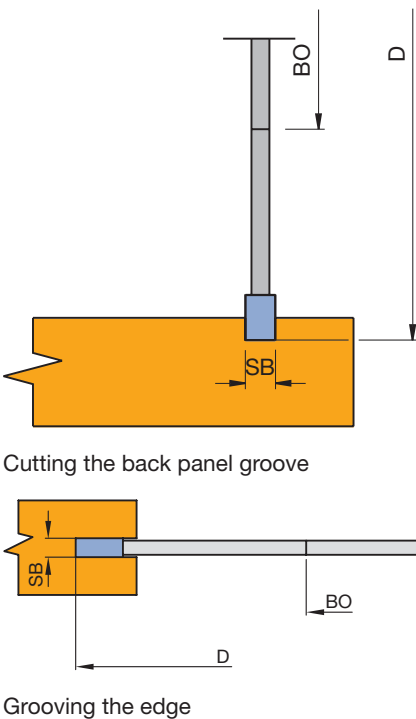
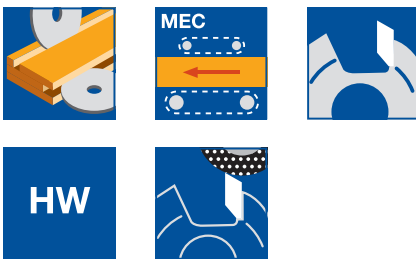

D	SB	TDI	BO	BO _{max}	Z	n _{max}	ID
mm	mm	mm	mm	mm		min ⁻¹	
80	4,0		16 DKN		3	12,000	182000
125	1.5	0.8	30	50	12	13,700	020145 ●
125	2,0	1.2	30	50	12	13,700	020147 ●
125	2.5	1.4	30	50	12	13,700	020149 ●
125	3,0	2,0	30	50	12	13,700	020150 ●
125	3.5	2.2	30	50	12	13,700	020151 ●
125	4,0	2.5	30	50	12	13,700	020152 ●
125	4.5	3,0	30	50	12	13,700	020153 ●
125	5,0	3.5	30	50	12	13,700	020191 ●
125	6,0	4.5	30	50	12	13,700	020192 ●
125	7,0	5,0	30	50	12	13,700	020193 ●
125	8,0	6,0	30	50	12	13,700	020194 ●
125	10,0	7,0	30	50	12	13,700	020196 ●
150	1.5	0.8	30	60	18	11,400	020164 ●
150	2,0	1.2	30	60	18	11,400	020166 ●
150	2.5	1.4	30	60	18	11,400	020168 ●
150	3,0	2,0	30	60	12	11,400	020154 ●
150	3,0	2,0	30	60	18	11,400	020169 ●
150	3.5	2.2	30	60	12	11,400	020155 ●
150	4,0	2.5	30	60	12	11,400	020156 ●
150	4,0	2.5	30	60	18	11,400	020170 ●
150	4.5	3,0	30	60	12	11,400	020157 ●
150	5,0	3.5	30	60	12	11,400	020158 ●
150	5,0	3.5	30	60	18	11,400	020171 ●
150	6,0	4.5	30	60	12	11,400	020159 ●
150	6,0	4.5	30	60	18	11,400	020172 ●
150	7,0	5,0	30	60	12	11,400	020160 ●
150	8,0	6,0	30	60	12	11,400	020161 ●
150	8,0	6,0	30	60	18	11,400	020173 ●
150	8.5	6,0	30	60	18	11,400	020319 ●
150	10,0	7,0	30	60	12	11,400	020163 ●
150	10,0	7,0	30	60	18	11,400	020174 ●
180	2,0	1.2	30	70	18	9,500	020202 ●
180	2.5	1.4	30	70	18	9,500	020203 ●
180	3,0	2,0	30	70	18	9,500	020204 ●
180	3.5	2.2	30	70	18	9,500	020205 ●
180	4,0	2.5	30	60	18	9,500	020197 ●
180	5,0	3.5	30	60	18	9,500	020198 ●
180	6,0	4.5	30	60	18	9,500	020199 ●
180	8,0	6,0	30	60	18	9,500	020200 ●
180	8.5	6,0	30	60	18	9,500	020320 ●
180	10,0	7,0	30	60	18	9,500	020201 ●
200	2,0	1.2	35	80	18	8,500	020299 ●
200	2.5	1.4	35	80	18	8,500	020301 ●
200	3,0	2,0	35	80	18	8,500	020302 ●
200	4,0	2.5	35	80	18	8,500	020303 ●
200	5,0	3.5	35	80	18	8,500	020304 ●
200	6,0	4.5	35	80	18	8,500	020305 ●
200	8,0	6,0	35	80	18	8,500	020306 ●
200	8.5	6,0	30	80	18	8,500	020321 ●
200	10,0	7,0	35	80	18	8,500	020307 ●



DP tipped

WF 100 2, WF 100 2 DP

D	SB	TDI	BO	BO _{max}	NLA	Z	ZF	QAL	n _{max}	ID
mm	mm	mm	mm	mm	mm				min ⁻¹	
80	4,0		16			3	FZ	DP		192334
150	4,0	2.5	30	60		18	FZ	DP	11,400	192304 ●
180	4,0	2.5	30	60		24	FZ	DP	9,500	192305 ●
180	8.5	6,5/8,5	80		4/9/100	35	WZ/WZ/	DP	9,500	190755 ●
					4/9/100		FZ			
200	4,0	2.5	30	80		24	FZ	DP	8,500	192306 ●

DP tipped, mounted on flanged sleeve ID 61681

SF 500 2

D	SB	BO	DKN	Z	ZF	QAL	n _{max}	ID
mm	mm	mm	mm				min ⁻¹	
180	8.5	35	10x43	35	WZ/WZ/FZ	DP	9,500	190756 □

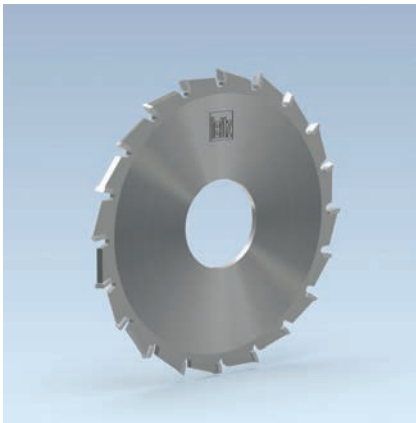

Circular sawblade for end trim on edgebanding machines

Application:

For low noise edgebanding trim cuts.

Machine:

Single or double-sided edgebanding machines and double-end tenoners.

Workpiece material:

Veneered, melamine and plastic edging.

Technical information:

Tooth geometries and pitch designed for optimum cutting quality.

Veneered and plastic edging:

Edging thickness ≥ 2.0 mm - crosscut saw ES pos.

Edging thickness < 2.0 mm - crosscut saw ES neg.



Circular sawblade - LowNoise, ES

SK 499 2, WK 101 2, WK 300 2, WK 301 2, WK 311 2, WK 321 2, WK 331 2, WK 372 2

Machine	D mm	SB mm	BO mm	NLA mm	Z	ZF	ID	
							LH	RH
Biesse	115	3.2	52	3/7,1/64	30	ES pos.	166420	166421
Biesse	115	3.2	56	3/7,1/68	30	ES pos.	166422	166423
Biesse	130	3.6	30	4/7,4/46	24	ES pos.	166424 ●	166425 ●
Biesse	140	3.2	30		36	ES pos.	166427 ●	166426 ●
Brandt	100	2.6	32		30	ES neg.	166400 ●	166401 ●
Brandt	100	2.6	32		30	ES pos.	166429 ●	166430 ●
Brandt	110	2.4	32		40	ES pos.	166432	166433
Brandt	125	2.6	32		30	ES neg.	166403 ●	166404 ●
Brandt	150	2.8	20		36	ES pos.	166434 ●	166435 ●
Cehisa	100	3.0	32		30	ES pos.	166436 ●	166437 ●
Fravol	100	3.2	22		24	ES pos.	166407 ●	166406 ●
Fravol	100	2.6	30		30	ES pos.	166476 ●	166477 ●
Fravol	125	3.2	22		30	ES pos.	166411 ●	166410 ●
Holz-Her	110	3.6	22		16	ES pos.	166439 ●	166440 ●
Homag	80	3.2	34	8/4,2/44	30	ES pos.	166443 ●	166444 ●
* Homag	100	3.0	32		20	ES pos.	166445 ●	166446 ●
Homag	100	3.2	32		20	ES neg.	166449 ●	166450 ●
Homag	100	2.6	32		30	ES neg.	166400 ●	166401 ●
Homag	100	2.6	32		30	ES pos.	166429 ●	166430 ●
Homag	110	2.4	32		40	ES pos.	166432	166433
Homag	110	1.7	40	4/5,5/52	30	FZ/TR pos.	166453 ●	166453 ●
* Homag	120	3.2	40		30	ES pos.	166454 ●	166455 ●
Homag	125	2.6	32		30	ES neg.	166403 ●	166404 ●
Homag	150	2.8	20		36	ES pos.	166434 ●	166435 ●
Homag	150	3.5	30	4/5,6/52	40	ES pos.	166458	166459
IDM	90	3.0	30		20	FZ pos.	166461	166461
SCM	150	3.8	35	4/6,5/50	30	ES pos.	166468 ●	166469 ●
Törk Makine	140	3.2	30		36	ES pos.	166417	166418
Wilmsmeyer	100	3.2	32		20	ES neg.	166449 ●	166450 ●

* = For 2 part set SK 499 2 use mounting flange ID **066750**.

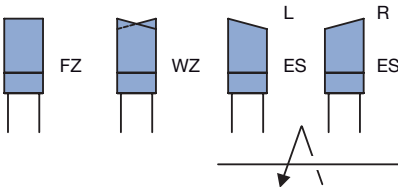

Workpiece material:

Softwood, hardwood edging.

Technical information:

Tooth geometries and pitch designed for optimum cutting quality.

Solid wood edging and multi-purpose application:Edging thickness ≥ 2.0 mm - crosscut saw WZ pos.Edging thickness < 2.0 mm - crosscut saw WZ neg.**Circular sawblade - LowNoise, WZ**

WK 250 2, WK 350 2, WK 360 2, WK 370 2, WK 380 2, WK 850 2

Machine	D	SB	BO	NLA	Z	ZF	ID	ID
	mm	mm	mm	mm			LH	RH
Biesse	100	3.2	30		20	WZ pos.	166478 ●	166478 ●
Biesse	160	3.2	20		48	WZ pos.	166428 ●	166428 ●
Brandt	100	2.6	32		30	WZ pos.	166431 ●	166431 ●
Brandt	125	2.4	32		24	WZ pos.	166402 ●	166402 ●
EBM	100	2.4	22	2/4/30	20	WZ neg.	166405 ●	166405 ●
Felder	100	3.2	22		20	WZ pos.	166438 ●	166438 ●
Felder	110	3.2	30		20	WZ pos.	166475 ●	166475 ●
Hebrock	100	2.4	22	2/4/30	20	WZ neg.	166428 ●	166428 ●
Holz-Her	110	3.6	22		20	WZ pos.	065663 ●	065663 ●
Holz-Her	120	3.2	22		20	WZ pos.	166474 ●	166474 ●
Holz-Her	140	3.2	22		36	WZ pos.	166441 ●	166441 ●
Holz-Her	160	3.2	20		48	WZ pos.	166428 ●	166428 ●
Holz-Her	160	3.2	30		24	WZ pos.	065664 ●	065664 ●
Homag	100	3.6	32		20	WZ pos.	166451 ●	166451 ●
Homag	100	2.6	32		30	WZ pos.	166431 ●	166431 ●
Homag	110	3.6	32		20	WZ pos.	166452 ●	166452 ●
Homag	120	3.6	40	8/5,6/52	24	WZ pos.	166419 ●	166419 ●
Homag	120	3.2	40	8/5,6/52	36	WZ pos.	166456 ●	166456 ●
Homag	120	3.6	40	8/5,6/52	36	WZ pos.	166457 ●	166457 ●
Homag	125	2.4	30	8/6,5/48	36	WZ pos.	058234 ●	058234 ●
Homag	125	2.4	32		24	WZ pos.	166402 ●	166402 ●
Homag	170	3.2	30	8/5,6/52	36	WZ pos.	166412 ●	166412 ●
Homag	180	3.2	30	4/5,6/52	54	WZ pos.	166460 ●	166460 ●
IMA	160	3.5	22		36	WZ neg.	166462 ●	166462 ●
IMA	160	3.2	22		48	WZ neg.	166414 ●	166414 ●
IMA	180	3.2	22		48	WZ pos.	166463 ●	166463 ●
IMA	180	3.2	22		48	WZ neg.	166464 ●	166464 ●
IMA	200	3.2	22		64	WZ pos.	166479 ●	166479 ●
IMA 08.415	180	3.5	22		42	WZ neg.	166415 ●	166415 ●
IMA 08.492	160	3,0	22		36	WZ pos.	166413 ●	166413 ●
Ott	140	3.2	16		36	WZ pos.	166466 ●	166466 ●
Raimann	100	3.6	32		20	WZ pos.	166451 ●	166451 ●
Raimann	120	3.2	32		20	WZ neg.	166467 ●	166467 ●
SCM	90	2.6	20		20	WZ	166483 ●	166483 ●
SCM	107	6,0	40		12	R3	166481 ●	166482 ●
SCM	115	3.2	30		30	WZ pos.	166416 ●	166416 ●
SCM	125	3.2	30		24	WZ	166480 ●	166480 ●

2. Panel processing

2.1 Edge processing

2.1.7 Edge finishing tools

Working processes	<p>Finishing plastic, veneered and solid wood edges of wood material boards.</p> <ul style="list-style-type: none"> - Pre-cutting to remove asymmetric edge protrusions on top and bottom edges and edge trimming solid wood edges. - Profiling a bevel or round edge on top and bottom edges. - Profiling a bevel and round edges on top and bottom edges and front and back. - Profile scrapers to remove knife marks. - Flat scrapers for excellent alignment of edge and workpiece.
Workpiece material	<p>Thick plastic edgebanding made from PVC, PP, ABS, thin plastic edgebanding made from melamine resin, veneer edgebanding, solid wood banding and edgebanding.</p>
Machines	<p>Single or double-sided edgebanding machines, double-end tenoners.</p>
Application	<p>Against feed for plastic edgebanding, preferably with feed for solid wood edge lippings.</p>
Technical features	<p>Tool and touch roller positions are coordinated, requiring constant tool dimensions. It is recommended not to resharpen edge processing tools.</p>
Chip disposal	<p>Tools with optimised chip collection are designed to the corresponding machines (i-System, ED-System), and guide the chips from the tool cutting edge into the extraction. Even at low extraction air speeds more than 97% of the chips are collected. This improves not only process efficiency and productivity, but also the working environment. New machines require less extraction.</p>



Pre / finishing edge trimming cutter

Application:

To trim edgebandings on horizontal spindles or for bevelling with inclined spindles.

Machine:

Single or double-sided edgebanding machines.

Workpiece material:

Plastic, softwood, hardwood and veneer edgebander.

Technical information:

HW/DP tipped tools with cylindrical bore.

Joining cutter

WF 200 2, WF 200 2 DP, WF 210 2, WF 210 2 DP

Machine	D mm	SB mm	ND mm	BO mm	Type	Z	QAL	ID LH	ID RH
Biesse	70	10	12	16	DKN 1	6	DP	090899	090899
Biesse	70	20	12	16	DKN 2	6	DP	090893	090893
Biesse	80	22	12	16	DKN 3	6	DP	192103 ●	192102 ●
Brandt	70	10	12	16	DKN 1	6	DP	090899	090899
Brandt	70	20	12	16	DKN 2	6	DP	090893	090893
Brandt	70	25	25	16	DKN 3	4	HW	065588 ●	065589 ●
Fravol	80	30	27.5	20	DKN 3	4	DP	192270 ●	192271 ●
Holz-Her 1828	70	19.5	19.5	20	DKN 4	4	HW	065592	065593
Homag	70	10	12	16	DKN 1	6	DP	090899	090899
Homag	70	20	12	16	DKN 2	6	DP	090893	090893
Homag	70	25	25	16	DKN 3	4	HW	065588 ●	065589 ●
Ott	70	16.5	10	16	DKN 3	4	DP	192283 ●	192284 ●
SCM	80	30	11	16	DKN 2	4	HW	065595 □	065596 □
Stefani	80	20	11	16	DKN 2	4	DP	192110 ●	192111 ●

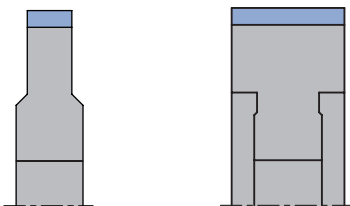
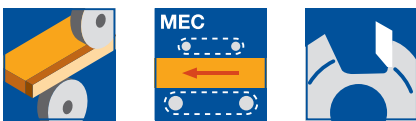

Type 1

Type 2

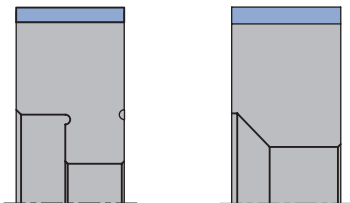

Type 3

Type 4

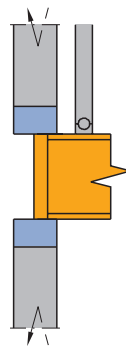

Trimming of edges on horizontal spindle - top motor tracing.

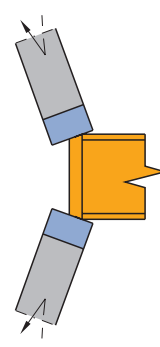

Bevelling of edges with inclined spindle.

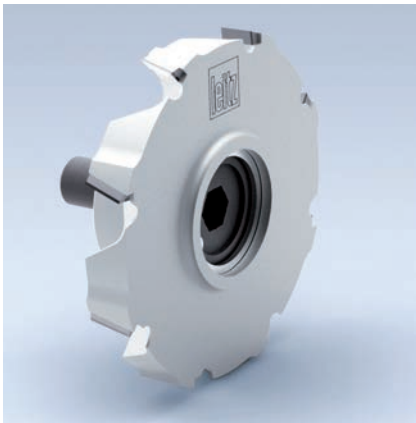

Pre / finishing edge trimming cutter with optimised chip collection

Application:

To trim edgebandings on horizontal spindles or for bevelling with inclined spindles.

Machine:

Single or double-sided edgebanding machines.

Workpiece material:

Plastic, softwood, hardwood and veneer edgebander.

Technical information:

HW/DP tipped tools designed for systems for controlled chip collection (i-System, ED-System) for highly efficient chip collection (approx. 97%) with reduced energy consumption for extraction. Clean workpieces, no interference with scanning aggregates and less rework. High concentricity.

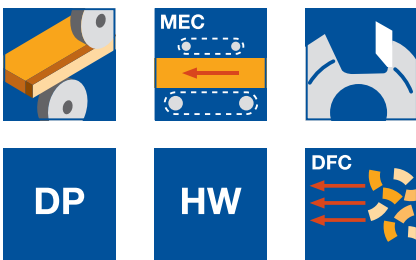

Joining cutter - optimised chip collection

WF 200 2 DP, WF 210 2, WF 210 2 DP

Machine	D mm	SB mm	BO mm	Z	QAL	ID	
						LH	RH
Homag, IMA	70	8	HSK 25 R	4	DP	● 198472	● 198473
Homag, IMA	70	8	HSK 25 R	6	DP	● 198474	● 198475
Homag, IMA	70	8	HSK 25 R	8	DP	● 198404	● 198405
Homag, IMA	70	15	HSK 25 R	4	DP	● 198406	● 198407
Homag, IMA	70	15	HSK 25 R	6	DP	● 198468	● 198469
Homag, IMA	70	25	HSK 25 R	4	HW	● 073092	● 073093
SCM	80	8	HSK 25 R	4	DP	● 192335	● 192336
SCM	80	30	HSK 25 R	4	HW	● 182001	● 182002

Recommended number of teeth:

Feed rates of up to 35 m min⁻¹ Z 4

Feed rates of up to 60 m min⁻¹ Z 6

Feed rates of up to 100 m min⁻¹ Z 8 (thin edge)

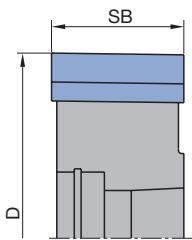

HW jointing cutter with HSK 25 R adaptor, SB-25 mm

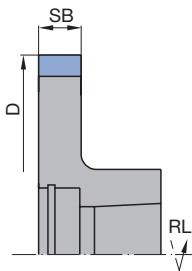

DP jointing cutter with HSK 25 R adaptor



Pre / finishing edge trimming cutter cutterhead design

Application:

To trim edgebandings on horizontal spindles or for bevelling with inclined spindles.

Machine:

Single or double-sided edgebanding machines.

Workpiece material:

Plastic, softwood, hardwood and veneer edgebander.

Technical information:

Cutterhead with turnblade knives, cylindrical bore or HSK 25 R adaptor.

Joining cutterhead

WW 200 2, WW 200 2 06, WW 200 2 25

Machine	Type	D mm	SB mm	BO mm	Z	ID LH	ID RH
Brandt, Homag	1	70	14.3	16 DKN	4	025130 ●	025130 ●
Homag	1	70	14.3	HSK 25 R	4	073599 ●	073600 ●
Homag	2	70	20	16 DKN	4	025079 ●	025079 ●
Ott, Holz-Her	2	70	20	16	4	025078	025078
Holz-Her 1962	2	80	40	30 KN	4	024415	024415

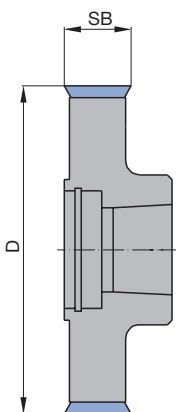
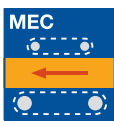
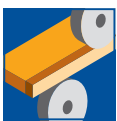

Type 1: WW 200 2 25

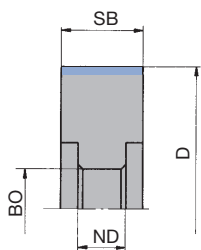

Type 2: WW 200 2 06

Spare knives:

Part-no.	BEZ	ABM mm	QAL	VE PCS	ID
1	Turnblade knife	20x12x1,5	HW-05F	10	005083 ●
1	Turnblade knife	40x12x1,5	HW-05F	10	005085 ●
5	Turnblade knife	14,3x14,3x2,5	HW	10	005426 ●

Spare parts:

Part-no.	BEZ	ABM mm	ID
2	Clamping wedge with pin	18x11,5x7	005272 ●
3	Allen screw	M6x12	006035
4	Allen key	SW 3	005444 ●
6	Countersink screw, Torx® 20	M5x12	006247 ●
7	Torx® key	Torx® 20	006091 ●

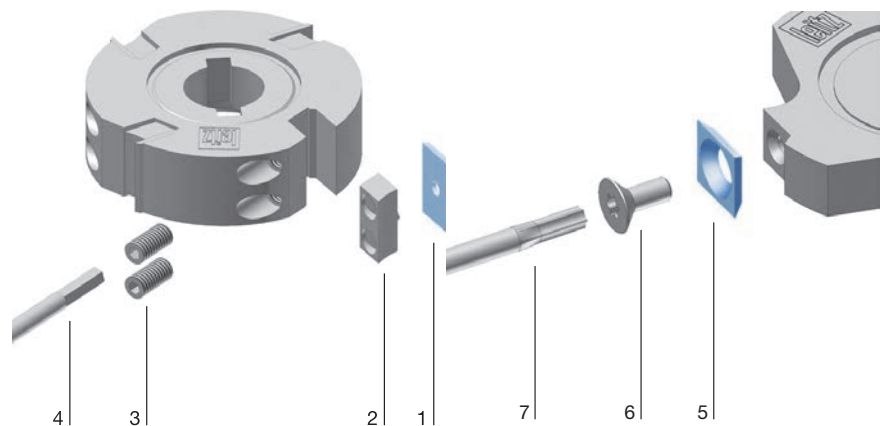



Bevel cutter

Application:

To bevel edgebandings.

Machine:

Single or double-sided edgebanding machines.

Workpiece material:

Plastic, softwood, hardwood and veneer edgebander.

Technical information:

HW/DP tipped tools with cylindrical bore, HSK 25 R or HSK 32 adaptor for FK aggregates.

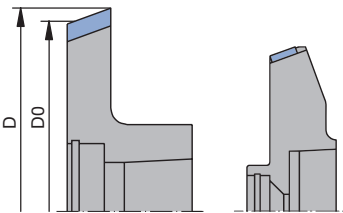
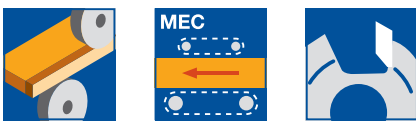

Type 1

Type 2

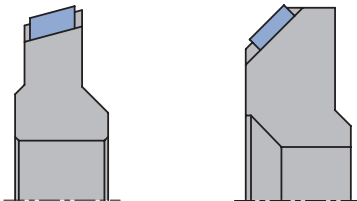

Type 3

Type 4

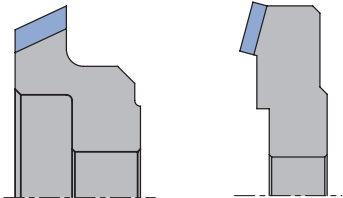

Type 5

Type 6

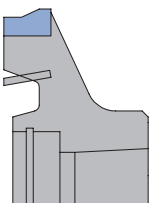

Type 7

Various bevel angles

WF 300 2 DP, WF 350 2 DP, WF 502 2

Machine	D mm	D ₀ mm	SB mm	BO mm	Z	QAL	FAW °	Type	ID LH	ID RH
Biesse	67.2	60	9	16 DKN	6	DP	25	5	091976	091975
Biesse	67.2	60	9	20 DKN	6	DP	25	5	091970	091969
Biesse	68.1	60	9	20 DKN	6	DP	45	5	091972	091971
Biesse	68.9	60	9	16 DKN	6	DP	45	5	091978	091977
Biesse	80	69.86	10.5	16 DKN	4	DP	15	6	091974	091973
Holz-Her 1825	52.1	50	6	16 DKN	2	DP	15	3	091982	091981
Holz-Her 1832	53.2	50	8	16 DKN	3	DP	15	3	091986	091985
Holz-Her 1832	56	50	5	16 DKN	3	DP	45	3	091988	091987
Holz-Her 1833	72.6	61	8	20 DKN	4	DP	45	4	091984	091983
Homag	64.5	62	5	HSK 32	4	DP	20	2	091518	091519
Homag	66	62	5	HSK 32	6	DP	30	2	091690	091691
Homag	67	62	5	HSK 32	6	DP	20	2	091658	091659
Homag	69	62	5	HSK 32	6	DP	45	2	091692	091693
Homag	74.7	70	8	HSK 25 R	4	DP	20	1	091790	091791
IMA	74.7	70	8	HSK 25 R	4	DP	20	1	091790	091791
SCM	66.7	63.9	8	HSK 25 R	4	HW	25	7	182536	182537
Stefani	73	61.7	5	12 DKN	4	DP	20	3	091980	091979

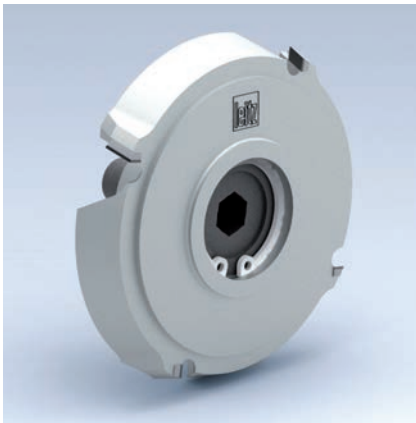

Bevel cutter with optimised chip collection

Application:
To bevel edgebandings.

Machine:
Single or double-sided edgebanding machines.

Workpiece material:
Plastic, softwood, hardwood and veneer edgebander.

Technical information:
DP tipped tools designed for systems for controlled chip collection (i-System, ED-System) for highly efficient chip collection (approx. 97%) with reduced energy consumption for extraction. Clean workpieces, no interference with scanning aggregates and less rework. High concentricity. Constant reference diameter.

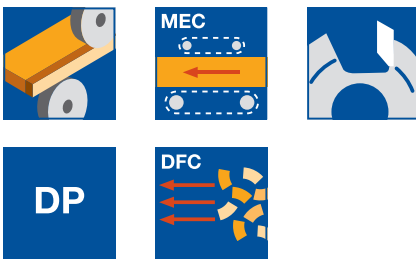

Various bevel angles - optimised chip collection

WF 300 2 DP, WF 350 2 DP

Machine	D	D ₀	SB	BO	Z	QAL	FAW	NH	ID	ID
	mm	mm	mm	mm			°	mm	LH	RH
Homag	65.14	62.3	5.7	HSK 32	4	DP	20	31.5	198200 ●	198201 ●
Homag	70	62.3	5.7	HSK 32	4	DP	45	31.5	198240 ●	198241 ●
Homag	65.14	62.3	5.7	HSK 32	6	DP	20	31.5	198202 ●	198203 ●
Homag	68.3	62.3	5.7	HSK 32	6	DP	45	31.5	198242 ●	198243 ●
Homag	72.91	70	5.5	HSK 25 R	4	DP	20	19.5	198408 ●	198409 ●
Homag	78	70	5.5	HSK 25 R	4	DP	45	19.5	198464 ●	198465 ●
Homag	73	70	5.5	HSK 25 R	6	DP	20	19.5	198410 ●	198411 ●
Homag	78	70	5.5	HSK 25 R	6	DP	45	19.5	198466 ●	198467 ●
IMA	72.91	70	5.5	HSK 25 R	4	DP	20	19.5	198408 ●	198409 ●
IMA	78	70	5.5	HSK 25 R	4	DP	45	19.5	198464 ●	198465 ●
IMA	73	70	5.5	HSK 25 R	6	DP	20	19.5	198410 ●	198411 ●
IMA	78	70	5.5	HSK 25 R	6	DP	45	19.5	198466 ●	198467 ●
SCM	69.6	62.5	5.5	HSK 25 R	4	DP	45	22	192707 □	192708 □
SCM	69.6	62.5	5.5	HSK 25 R	4	DP	30	22	192705 □	192706 □
SCM	69.6	62.5	5.5	HSK 25 R	4	DP	20	22	192703 □	192704 □

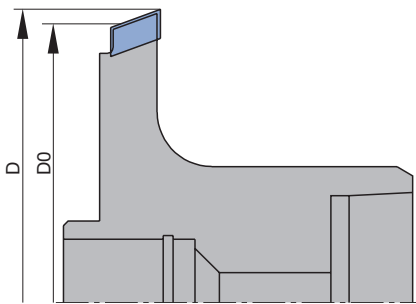

Bevel cutter with HSK 32 adaptor for FK aggregates

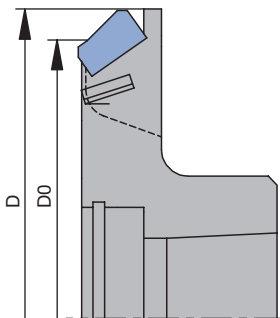

Bevel cutter with HSK 25 R adaptor



Profile cutter

Application:

To round edgebandings.

Machine:

Single or double-sided edgebanding machines.

Workpiece material:

Plastic, softwood, hardwood and veneer edgebander.

Technical information:

HW/DP tipped tools with cylindrical bore, HSK 25 R adaptor or HSK 32 adaptor for FK-aggregates. High concentricity. D_0 = constant reference diameter.

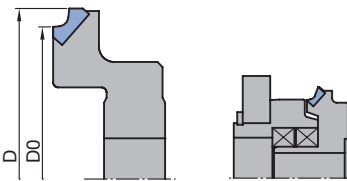
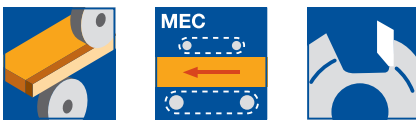

Type 1

Type 2

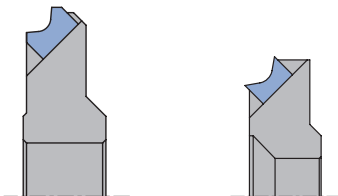

Type 3

Type 4

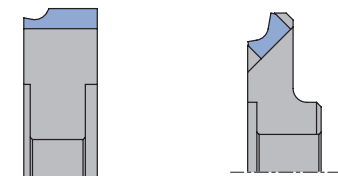

Type 5

Type 6

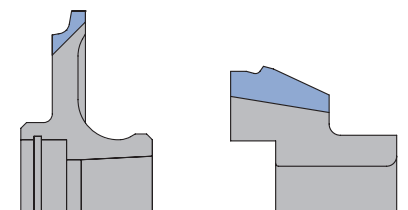

Type 7

Type 8

Various radii

WF 210 2 DP, WF 501 2, WF 501 2 DP, WF 502 2, WF 502 2 DP, WF 599 2

Machine	D mm	D_0 mm	BO mm	Z	QAL	R mm	Type	ID LH	ID RH
Biesse	67	60	16 DKN	6	DP	1,0	1	091960 ●	091961 ●
Biesse	68	60	16 DKN	6	DP	2,0	1	091962 ●	091963 ●
Biesse	70	60	16 DKN	6	DP	3,0	1	091964 ●	091965 ●
Biesse	72	70	16 KN	6	DP	1,0	5	192518 ●	192519 ●
Biesse	73	70	16 KN	6	DP	2,0	5	192520 ●	192521 ●
Biesse	75	70	16 KN	6	DP	3,0	5	192522 ●	192523 ●
* Brandt	58	50	16	4	DP	1,0	2		091999 □
** Brandt	58	50	16	4	DP	1,5	2		192602 ●
* Brandt	58	50	16	4	DP	2,0	2		091966 ●
** Brandt	58	50	16	4	DP	2,0	2		192603 ●
Brandt	70	62	HSK 25 R	4	DP	1,0	7	192588 ●	192589 ●
Brandt	70	62	HSK 25 R	4	DP	1,3	7	192590 ●	192591 ●
Brandt	70	62	HSK 25 R	4	DP	1,5	7	192592 ●	192593 ●
Brandt	70	62	HSK 25 R	4	DP	2,0	7	192594 ●	192595 ●
Brandt	70	62	HSK 25 R	4	DP	3,0	7	192596 ●	192597 ●
EBM	32	24	14 DKN	2	DP	2,0	3	074526 ●	
EBM	56	49.7	16 DKN	2	DP	2,0	6	192669 ●	192670 ●
EBM	56	49.7	16 DKN	2	DP	2,5	6	192641 ●	192642 ●
Fravol	73	71.15	20 DKN	4	DP	1-3	8	192645 ●	192646 ●
Fravol	76.8	74.71	20 DKN	4	DP	1-3	9	192647 ●	192648 ●
Fravol	50	40.1	15 KN	4	DP	1-3	10	192663 ●	192664 ●
Fravol	50	39.91	15 KN	4	DP	1-3	11		192665 ●
Fravol	50	39.91	15 KN	6	HW	1-3	11		065594 ●
Hebrock	32	24	14 DKN	2	DP	2,0	3	074526 ●	
Hebrock	56	49.7	16 DKN	2	DP	2,0	6	192669 ●	192670 ●
Hebrock	56	49.7	16 DKN	2	DP	2,5	6	192641 ●	192642 ●
Holz-Her 1825	57	50	16 DKN	2	DP	2,0	3	192536 ●	192537 ●
Holz-Her 1825	57	50	16 DKN	2	DP	2,5	3	192538 ●	192539 ●
Holz-Her 1825	57	50	16 DKN	2	DP	3,0	3	192540 ●	192541 ●
Holz-Her 1827	56	50	20 DKN	2	DP	2,0	4	192506 ●	192507 ●
Holz-Her 1827	56	50	20 DKN	2	DP	2,5	4	192508 ●	192509 ●
Holz-Her 1827	57	50	20 DKN	2	DP	3,0	4	192510 ●	192511 ●
Holz-Her 1832	58.7	50	16 DKN	3	DP	2,0	3	192512 ●	192513 ●
Holz-Her 1832	58.7	50	16 DKN	3	DP	2,5	3	192514 ●	192515 ●
Holz-Her 1832	58.7	50	16 DKN	3	DP	3,0	3	192516 ●	192517 ●
Holz-Her 1833	72.5	61	20 DKN	4	DP	2,0	4	192500 ●	192501 ●
Holz-Her 1833	72.5	61	20 DKN	4	DP	2,5	4	192502 ●	192503 ●
Holz-Her 1833	72.5	61	20 DKN	4	DP	3,0	4	192504 ●	192505 ●

* For Brandt edge trimming cutter with keyed and torque support.

** = For Brandt edge trimming cutter with keyed (without torque support).

2. Panel processing

2.1 Edge processing 2.1.7 Edge finishing tools

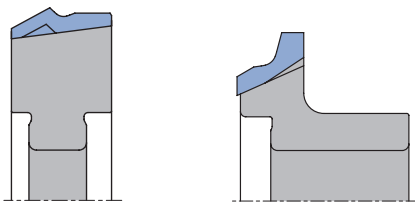

Type 9

Type 10

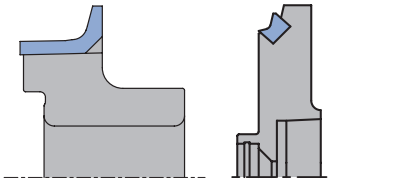

Type 11

Type 12

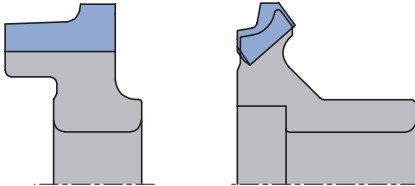

Type 13

Type 14

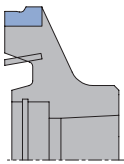

Type 15

Machine	D	D ₀	BO	Z	QAL	R	Type	ID	ID
	mm	mm	mm			mm		LH	RH
* Homag	58	50	16	4	DP	1,0	2		091999 □
** Homag	58	50	16	4	DP	1,5	2		192602 ●
* Homag	58	50	16	4	DP	2,0	2		091966 ●
** Homag	58	50	16	4	DP	2,0	2		192603 ●
Homag	70	62	HSK 25 R	4	DP	1,0	7	192588 ●	192589 ●
Homag	70	62	HSK 25 R	4	DP	1,3	7	192590 ●	192591 ●
Homag	70	62	HSK 25 R	4	DP	1,5	7	192592 ●	192593 ●
Homag	70	62	HSK 25 R	4	DP	2,0	7	192594 ●	192595 ●
Homag	70	62	HSK 25 R	4	DP	3,0	7	192596 ●	192597 ●
Homag	67.1	62	HSK 32	4	DP	1,0	12	091500 □	091501 □
Homag	68.1	62	HSK 32	4	DP	1,5	12	091502 □	091503 □
Homag	69.1	62	HSK 32	4	DP	2,0	12	091504 □	091505 □
Homag	70.1	62	HSK 32	4	DP	2,5	12	091506 □	091507 □
Homag	71.2	62	HSK 32	4	DP	3,0	12	091508 □	091509 □
Homag	67.05	62	HSK 32	6	DP	1,0	12	091672	091673
Homag	68.08	62	HSK 32	6	DP	1,5	12	091674	091675
Homag	69.1	62	HSK 32	6	DP	2,0	12	091650	091651
Homag	70.13	62	HSK 32	6	DP	2,5	12	091676	091677
Homag	71.16	62	HSK 32	6	DP	3,0	12	091652	091653
Ott	69	61	16 DKN	3	DP	2,0	1	192649 ●	192650 ●
Ott	69	61	16 DKN	4	DP	2,0	1	192651 ●	192652 ●
SCM	55.3	49.33	16 DKN	3	DP	2,0	13	192701	192702
SCM	55.3	49.33	16 DKN	3	HW	2,0	13	182510 ●	182511 ●
SCM	55.7	48	16 DKN	3	HW	1,0	14	182512 □	182513 □
SCM	55.7	48	16 DKN	3	HW	1,5	14	182514 □	182515 □
SCM	55.7	48	16 DKN	3	HW	2,0	14	182516 □	182517 □
SCM	55.7	48	16 DKN	3	HW	3,0	14	182518 □	182519 □
SCM	65.82	63.88	HSK 25 R	4	HW	1,0	15	182526 □	182527 □
SCM	66.44	63.88	HSK 25 R	4	HW	1,5	15	182528 □	182529 □
SCM	67.09	63.88	HSK 25 R	4	HW	2,0	15	182530 □	182531 □
SCM	67.55	63.88	HSK 25 R	4	HW	2,5	15	182532 □	182533 □
SCM	68	63.88	HSK 25 R	4	HW	3,0	15	182534 □	182535 □
Stefani	70	60	16 DKN	4	DP	1,0	6	192524 ●	192525 ●
Stefani	70	60	16 DKN	4	DP	2,0	6	192526 ●	192527 ●
Stefani	70	60	16 DKN	4	DP	3,0	6	192528 ●	192529 ●
Stefani	51.5	49.71	16 DKN	4	HW	1,0	8	192657 ●	192658 ●
Stefani	51.5	49.71	16 DKN	4	HW	1,5	8	192659 ●	192660 ●
Stefani	51.5	49.71	16 DKN	4	HW	2,0	8	192661 ●	192662 ●
Törk Makine	46	39	16	4	DP	2,0	3	192643	192644

* For Brandt edge trimming cutter with keyed and torque support.

** = For Brandt edge trimming cutter with keyed (without torque support).



Profile cutter with optimised chip collection

Application:

To round edgebandings.

Machine:

Single or double-sided edgebanding machines.

Workpiece material:

Plastic, softwood, hardwood and veneer edgebander.

Technical information:

HW/DP tipped tools designed for systems for controlled chip collection (i-System, ED-System) for highly efficient chip collection (approx. 97%) with reduced energy consumption for extraction. Clean workpieces, no interference with scanning aggregates and less rework. Maximum concentricity. Constant reference diameter.

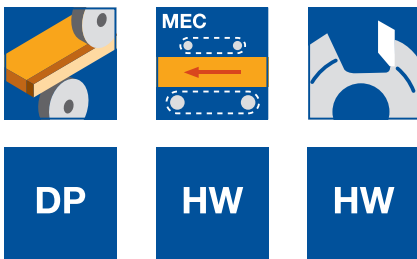

Various radii - optimised chip collection

WF 210 2 DP, WF 501 2, WF 501 2 DP

Machine	D	D ₀	NH	BO	Z	QAL	R	ID	ID
	mm	mm	mm	mm			mm	LH	RH
Homag	75	62	31.5	HSK 32	4	DP	1,0	198212 ●	198213 ●
Homag	75	62	31.5	HSK 32	4	DP	1.5	198214 ●	198215 ●
Homag	75	62	31.5	HSK 32	4	DP	2,0	198216 ●	198217 ●
Homag	75	62	31.5	HSK 32	4	DP	2.5	198220 ●	198221 ●
Homag	75	62	31.5	HSK 32	4	DP	3,0	198222 ●	198223 ●
Homag	75	62	31.5	HSK 32	6	DP	1,0	198246 ●	198247 ●
Homag	75	62	31.5	HSK 32	6	DP	1.5	198244 ●	198245 ●
Homag	75	62	31.5	HSK 32	6	DP	2,0	198218 ●	198219 ●
Homag	75	62	31.5	HSK 32	6	DP	2.5	198238 ●	198239 ●
Homag	75	62	31.5	HSK 32	6	DP	3,0	198224 ●	198225 ●
Homag, IMA	76	70	17.5	HSK 25 R	4	DP	1,0	198494 ●	198484 ●
Homag, IMA	76	70	17.5	HSK 25 R	4	DP	1.5	198495 ●	198485 ●
Homag, IMA	76	70	18.5	HSK 25 R	4	DP	2,0	198496 ●	198486 ●
Homag, IMA	76	70	17.5	HSK 25 R	6	DP	1,0	198499 ●	198489 ●
Homag, IMA	76	70	17.5	HSK 25 R	6	DP	1.5	198500 ●	198490 ●
Homag, IMA	76	70	18.5	HSK 25 R	6	DP	2,0	198501 ●	198491 ●
Homag, IMA	78	70	19	HSK 25 R	4	DP	2.5	198497 ●	198487 ●
Homag, IMA	78	70	19.5	HSK 25 R	4	DP	3,0	198498 ●	198488 ●
Homag, IMA	78	70	19	HSK 25 R	6	DP	2.5	198502 ●	198492 ●
Homag, IMA	78	70	19.5	HSK 25 R	6	DP	3,0	198503 ●	198493 ●
SCM	55.3	48	11.4	16 DKN	3	DP	1,0	192699	192700
SCM	55.3	48	11.4	16 DKN	3	HW	1,0	182502 □	182503 □
SCM	55.3	48	11.4	16 DKN	3	HW	1.5	182504 □	182505 □
SCM	55.3	48	11.4	16 DKN	3	DP	2,0	192697 ●	192698 ●
SCM	55.3	48	11.4	16 DKN	3	HW	2,0	182506 □	182507 □
SCM	55.3	48	11.4	16 DKN	3	HW	3,0	182508 □	182509 □
SCM	69.9	62.3	22	HSK 25 R	4	DP	1,0	192709 □	192710 □
SCM	69.9	62.3	22	HSK 25 R	4	DP	1.5	192711 □	192712 □
SCM	69.9	62.3	22	HSK 25 R	4	DP	2,0	192713 □	192714 □
SCM	69.9	62.3	22	HSK 25 R	4	DP	2.5	192715 □	192716 □
SCM	69.9	62.3	22	HSK 25 R	4	DP	3,0	192717 □	192718 □

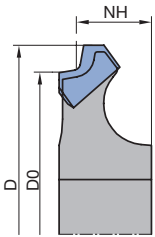

Radius cutter with cylindrical bore

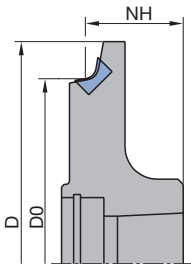

Radius cutter with HSK 25 R adaptor

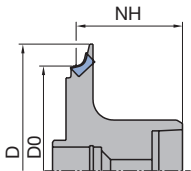

Radius cutter with HSK 32 adaptor for FK aggregates



Multi-profile cutter

Application:

For a choice of radii or bevels on edgebandings.

Machine:

Single or double-sided edgebanding machines.

Workpiece material:

Plastic, softwood, hardwood and veneer edgebander.

Technical information:

HW/DP tipped tools with cylindrical bore or HSK 25 R adaptor. Profiling with e.g. radii 2.0 and 3.0 mm and bevel 20°. D₀ = constant reference diameter.

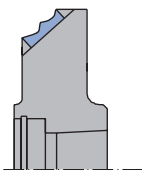
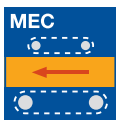
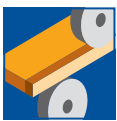

Type 1

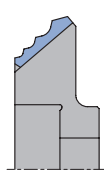

Type 2

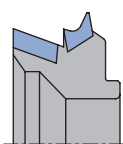

Type 3

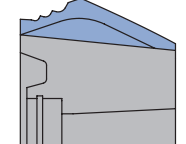

Type 4

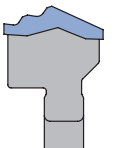

Type 5

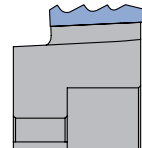

Type 6

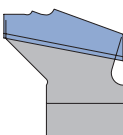

Type 7

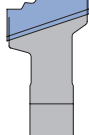

Type 8

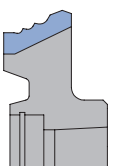

Type 9

Multi-profile cutter

WF 210 2, WF 210 2 DP, WF 501 2, WF 501 2 DP, WF 501 2 DP, WF 502 2, WF 502 2 DP, WF 502 2 DP

Machine	D	D ₀	BO	Z	QAL	R	FAW	Type	ID	ID
	mm	mm	mm			mm	°	LH	RH	
Biesse	75.4	60	16 DKN	6	DP	1/2/3	25	2	091996 ●	091995 ●
Brandt	78	57.3	16 DKN	4	DP	1,2/2/3	15	2	091967 ●	091968 ●
Holz-Her	58	50	20 DKN	2	DP	2		3	192530 ●	192531 ●
Holz-Her	58	50	20 DKN	2	DP	2.5		3	192532 ●	192533 ●
Holz-Her	58	50	20 DKN	2	DP	3		3	192534 ●	192535 ●
Holz-Her	58	50	20 DKN	2	DP	2		3	192530 ●	192531 ●
1826										
Holz-Her	58	50	20 DKN	2	DP	2.5		3	192532 ●	192533 ●
1826										
Holz-Her	58	50	20 DKN	2	DP	3		3	192534 ●	192535 ●
1826										
Holz-Her	71	68	16 DKN	4	DP	3/2/1,3	45	6	192673 ●	192674 ●
FR 701										
Holz-Her	71	68	16 DKN	4	DP	1,3/1/0,8	45	6	192681 ●	192682 ●
FR 701										
Holz-Her	71	68	16 DKN	4	DP	3/2/1,3	10	6	192679 ●	192680 ●
FR 701										
Holz-Her	71	68	16 DKN	4	DP	2/1,3/1,3	45	6	192677 ●	192678 ●
FR 701										
Holz-Her	71	68	16 DKN	4	DP	2/2/1,3	45	6	192675 ●	192676 ●
FR 701										
Homag	74.33	65.7	HSK 25 R	4	DP	1/2		4	198506 ●	198507 ●
Homag	74.67	65.7	HSK 25 R	4	DP	1,3/2		4	198508 ●	198509 ●
Homag	85	65.2	HSK 25 R	4	DP	2/3	20	1	091798 ●	091799 ●
Homag	74.33	62.99	16 DKN	4	DP	1/2		5	192683 ●	192684 ●
Homag	74.66	65.69	16 DKN	4	DP	1,3/2		5	192685 ●	192686 ●
Homag	78	57.3	16 DKN	4	DP	1,2/2/3	15	2	091967 ●	091968 ●
IMA	85	65.2	HSK 25 R	4	DP	2/3	20	1	091798 ●	091799 ●
SCM	74.5	63.9	HSK 25 R	4	HW	1/1,5/2		9	182538 □	182539 □
SCM	74.5	63.9	HSK 25 R	4	HW	1/1,5/3		9	182540 □	182541 □
SCM	74.5	63.9	HSK 25 R	4	HW	1/2/3		9	182542 □	182543 □
SCM	75.7	63.9	HSK 25 R	4	HW	1,5/2/3		9	182544 □	182545 □
SCM	75.7	63.9	HSK 25 R	4	HW	1/1,5/2,5		9	182558 □	182559 □
SCM	75.7	63.9	HSK 25 R	4	HW	2/2,5/3		9	182560 □	182561 □
SCM	62.03	49.44	16 DKN	4	HW	1/1,5		7	182522 □	182523 □
SCM	62.47	50.12	16 DKN	4	HW	1/2		7	182520 □	182521 □
SCM	73	60	16 DKN	4	HW	2/3		8	182501 □	182500 □
SCM	73	60	16 DKN	4	DP	2/3		8	192696 ●	192695 ●
SCM	77.4	63.1	16 DKN	4	HW	1/1,5/2		8	182524 □	182525 □
Stefani	74.5	63.88	HSK 25 R	4	DP	1/1,5/2	20	1	192653 ●	192654 ●
Stefani	74.5	63.88	HSK 25 R	4	DP	1/1,5/2	20	4	192655 ●	192656 ●

Alternative multi-profile trimming heads with different dimensions can be supplied at short notice on request.

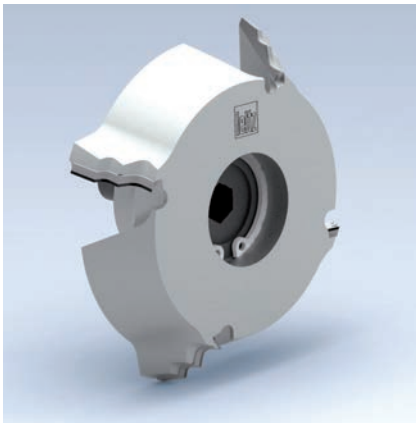

Multi-profile cutter with optimised chip collection

Application:

For a choice of radii or bevels on edgebandings.

Machine:

Single or double-sided edgebanding machines.

Workpiece material:

Plastic, softwood, hardwood and veneer edgebander.

Technical information:

DP tipped tools designed for systems for controlled chip collection (i-System, ED-System) for highly efficient chip collection (approx. 97%) with reduced energy consumption for extraction. Clean workpieces, no interference with scanning aggregates and less rework. High concentricity.

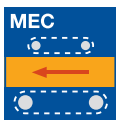
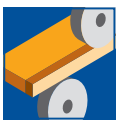

Multi-profile cutter - optimised chip collection

WF 501 2 DP, WF 502 2 DP

Machine	D	D ₀	B	BO	Z	QAL	R	FAW	Type	ID	ID
	mm	mm	mm	mm			mm	°	LH	RH	
Homag, IMA	85	62		HSK 25 R 4 DP	2/3		20	1	198444	198445	●
Homag, IMA	85	62		HSK 25 R 4 DP	1,5/2		20	1	198504	198505	●
Homag, IMA	85	62		HSK 25 R 6 DP	2/3		20	1	198456	198457	●
IMA Mul- tiprofiler	75		30	HSK 25 R 6 DP	1/2/3		15	2	091916	091917	●
IMA Mul- tiprofiler	75		30	HSK 25 R 6 DP	1/1,5/2		20	2	091922	091923	●
IMA Mul- tiprofiler	75		28	HSK 25 R 6 DP	1/2/3		15	2	091912	091913	●
IMA Mul- tiprofiler	75		28	HSK 25 R 6 DP	1/1,5/2		20	2	091924	091925	●
IMA Mul- tiprofiler	75		28	HSK 25 R 6 DP	1/2/3		45	2	091926	091927	●
IMA MFA	89	62		HSK 25 R 6 DP	1/2		15	3	091918	091919	●
IMA MFA	89	57		HSK 25 R 6 DP	1/2/3		15	3	091920	091921	●

Alternative multi-profile trimming heads with different dimensions can be supplied at short notice on request.

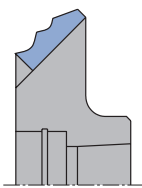

Type 1

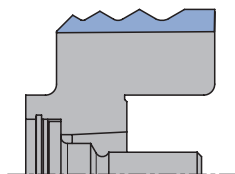

Type 2

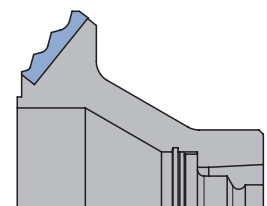

Type 3

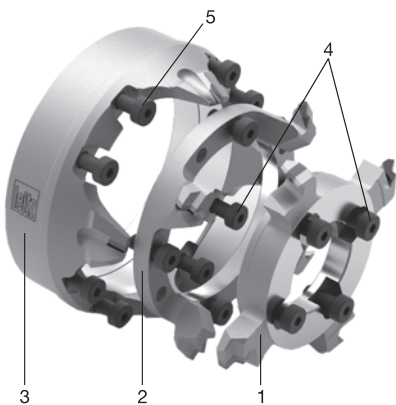
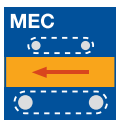
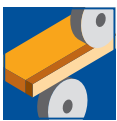

Multi-profile cutter with optimised chip collection

Application:

For multi-profile cutting with radii and bevelling of edges. Combination of three profiles for automatic profile resetting.

Machine:

Homag edgebanding machines with profile FK31 trimming aggregate.

Workpiece material:

Plastic, softwood, hardwood and veneer edgebander.

Technical information:

Three profiles in one tool. DFC design for highly efficient chip clearance of more than 97%. D_0 = constant reference diameter. Low noise DP tool. Maximum concentricity. Tool change while the spindle is running. It is recommended to have individual tools changed by the Leitz tool service.

Diamaster PRO, FK31 aggregate

WF 300 2 DP, WF 501 2 DP

Machine	Tool no.	D mm	D_0 mm	BO mm	Z	QAL	R mm	FAW °	ID LH	ID RH
Homag	1	88	80.1	46	4	DP	1.5		192558 ●	192559 ●
Homag	1	88	80.1	46	4	DP	2,0		192556 ●	192557 ●
Homag	1	88	80.1	46	4	DP	2.2		192580 ●	192581 ●
Homag	1	88	80.1	46	4	DP	2.5		192554 ●	192555 ●
Homag	1	88	80.1	46	4	DP	3,0		192552 ●	192553 ●
Homag	2	87	80.1	55	4	DP	1,0		192568 ●	192569 ●
Homag	2	87	80.1	55	4	DP	1.5		192566 ●	192567 ●
Homag	2	87	80.1	55	4	DP	1.7		192582 ●	192583 ●
Homag	2	87	80.1	55	4	DP	2,0		192564 ●	192565 ●
Homag	2	87	80.1	55	4	DP	2.5		192562 ●	192563 ●
Homag	2	87	80.1	55	4	DP	3,0		192560 ●	192561 ●
Homag	2	87	80.1	55	4	DP		45	192112 ●	192113 ●
Homag	2	87	80.1	55	4	DP		30	192123 ●	192124 ●
Homag	2	87	80.1	55	4	DP		20	192114 ●	192115 ●
Homag	3	92	80.1	73	4	DP	1,0		192574 ●	192575 ●
Homag	3	92	80.1	73	4	DP	1.5		192572 ●	192573 ●
Homag	3	92	80.1	73	4	DP	1.7		192584 ●	192585 ●
Homag	3	92	80.1	73	4	DP	2,0		192570 ●	192571 ●
Homag	3	92	80.1	73	4	DP		15	091520 ●	091521 ●
Homag	3	92	80.1	73	4	DP		20	192118 ●	192119 ●
Homag	3	92	80.1	73	4	DP		30	192125 ●	192126 ●
Homag	3	92	80.1	73	4	DP		45	192116 ●	192117 ●

Differing radii available at short notice from a tool bank. Tool 1 radius must be greater than tool 2 and 3. The larger radius defines the maximal bevel size of the moveable bevel tools 2 and 3.

Spare parts:

Part-no.	BEZ	ABM mm	ID
4	Cylindrical screw with ISK	M5x12	114046 ●
5	Cylindrical screw with ISK	M5x30	114045 ●
	Allen key	SW 3	005444 ●

Tools supplied with mounting screws.



Profile cutter flexTrim

Application:

For multi-profile cutting with radii and bevelling of edges. Combination of two profiles for automatic profile resetting in the workpiece gap.

Machine:

Homag edgebanding machines with cutting unit type FK11, FK20, FK21, FF12, FF32, PF21 with flexTrim cutting head.

Workpiece material:

Plastic, softwood, hardwood and veneer edgebander.

Technical information:

Two profiles in one tool. DFC design for efficient chip collection. Maximum processing quality through high running accuracy and smooth running. D_0 = constant reference diameter, $RPM n_{max} = 18000 \text{ min}^{-1}$. It is recommended to have individual tools changed by the Leitz tool service.

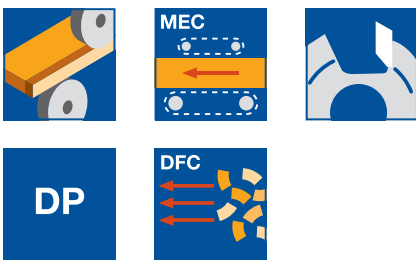

Multi-profile cutterset flexTrim - Diamaster PRO

SF 542 2 15

Machine	D	D ₀	NH	BO	Z	QAL	R	FAW	ID	ID
	mm	mm	mm	mm			mm	°	LH	RH
Homag	78	70	19.5	HSK 25 R 4	DP	1,5/1,0			194300 ●	194301 ●
Homag	78	70	19.5	HSK 25 R 4	DP	2,0/1,0			194302 ●	194303 ●
Homag	78	70	19.5	HSK 25 R 4	DP	2,0/1,5			194304 ●	194305 ●
Homag	78	70	19.5	HSK 25 R 4	DP	3,0/2,0			194306 ●	194307 ●
Homag	78	70	19.5	HSK 25 R 4	DP	2,0	20		194308 ●	194309 ●
Homag	78	70	19.5	HSK 25 R 4	DP	2,0	45		194310 ●	194311 ●

Tool 1 fix + tool 2 flexible

All tools and further profile variants available in various dimensions from blank at short notice. Further combinations possible on request.

Spare parts:

Part-no.	Tool no.	BEZ	ABM	ID
3	2	O-Ring	mm 40x1.78 NBR70	118300 ●

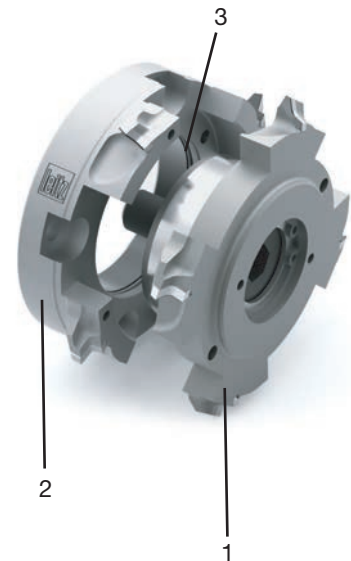
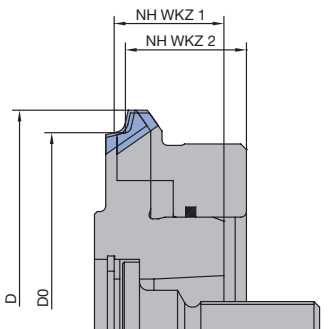

1 = Werkzeug 1
2 = Werkzeug 2
3 = O-Ring

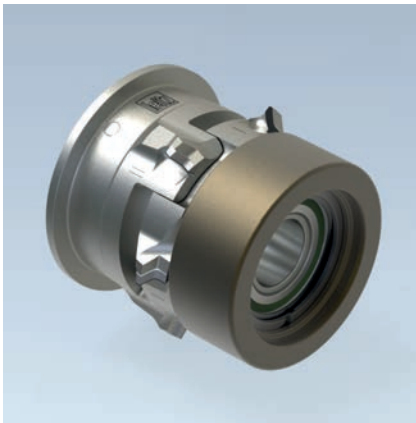

Profile cutter flexTrim

Application:

For multi-profile cutting with radii and bevelling of edges. Combination of two profiles for automatic profile resetting.

Machine:

Homag edgebanding machines with cutting unit type FF6210.

Workpiece material:

Plastic, softwood, hardwood and veneer edgebander.

Technical information:

Two profiles in one tool. Alternatively with only one profile. Maximum processing quality through high running accuracy and smooth running. D_0 = constant reference diameter, $RPM\ n_{max} = 12000\ min^{-1}$.

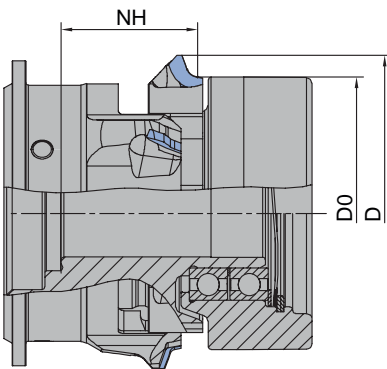
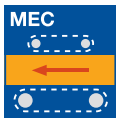
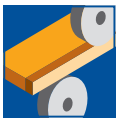

Multi-profile cutterset flexTrim - Diamaster PRO, aggregate FF6210

SF 542 2 18, WF 501 2 18

Machine	D	D ₀	NH	BO	Z	QAL	R	FAW	ID
	mm	mm	mm	mm			mm	°	RH
Homag	58	50	25	16	3	DP	3,0/1,0		194700 □
Homag	58	50	25	16	3	DP	3,0/1,3		194701 □
Homag	58	50	25	16	3	DP	3,0/2,0		194702 □
Homag	58	50	25	16	3	DP	2,0/1,0		194703 ●
Homag	58	50	25	16	3	DP	2,0/1,3		194704 ●
Homag	58	50	25	16	3	DP	2,0/1,5		194705 □
Homag	58	50	25	16	3	DP	2,0	45	194706 □
Homag	58	50	25	16	3	DP	1,5/1,5		194707 □
Homag	58	50	25	16	3	DP	3,0		194724 □
Homag	58	50	25	16	3	DP	2,0		194725 ●
Homag	58	50	25	16	3	DP	1,5		194726 ●
Homag	58	50	25	16	3	DP	1,3		194727 □
Homag	58	50	25	16	3	DP	1,0		194728 □
Homag	58	50	25	16	3	DP		45	194729 □
Homag	58	50	25	16	3	DP		30	194730 □
Homag	58	50	25	16	3	DP		15	194731 □

Further profile variants and combinations possible on request.



Profile cutter flexTrim

Application:

For multi-profile cutting with radii and bevelling of edges. Combination of two profiles for automatic profile resetting.

Machine:

Homag edgebanding machines with cutting unit type MF50, MF60.

Workpiece material:

Plastic, softwood, hardwood and veneer edgebander.

Technical information:

Two profiles in one tool. Alternatively with only one profile. Maximum processing quality through high running accuracy and smooth running. D_0 = constant reference diameter, $RPM n_{max} = 12000 \text{ min}^{-1}$.

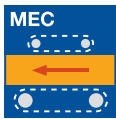
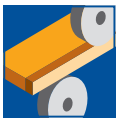

Multi-profile cutterset flexTrim - Diamaster PRO, aggregate MF50, MF60

SF 542 2 18, WF 501 2 18

Machine	D	D ₀	NH	BO	Z	QAL	R	FAW	ID	ID
	mm	mm	mm	mm			mm	°	LH	RH
Homag	70	62	35	HSK 25 R	4	DP	3,0/1,0		194708	194709
Homag	70	62	35	HSK 25 R	4	DP	3,0/1,3		194710	194711
Homag	70	62	35	HSK 25 R	4	DP	3,0/2,0		194712	194713
Homag	70	62	35	HSK 25 R	4	DP	2,0/1,0		194714	194715
Homag	70	62	35	HSK 25 R	4	DP	2,0/1,3		194716	194717
Homag	70	62	35	HSK 25 R	4	DP	2,0/1,5		194718	194719
Homag	70	62	35	HSK 25 R	4	DP	2,0	45	194720	194721
Homag	70	62	35	HSK 25 R	4	DP	1,5/1,5		194722	194723
Homag	70	62	35	HSK 25 R	4	DP	1,3/1,0		194732	194733
Homag	70	62	35	HSK 25 R	4	DP	3,0		194740	194741
Homag	70	62	35	HSK 25 R	4	DP	2,0		194742	194743
Homag	70	62	35	HSK 25 R	4	DP	1,5		194744	194745
Homag	70	62	35	HSK 25 R	4	DP	1,3		194746	194747
Homag	70	62	35	HSK 25 R	4	DP	1,0		194748	194749
Homag	70	62	35	HSK 25 R	4	DP		45	194750	194751
Homag	70	62	35	HSK 25 R	4	DP		30	194752	194753
Homag	70	62	35	HSK 25 R	4	DP		15	194754	194755

Further profile variants and combinations possible on request.

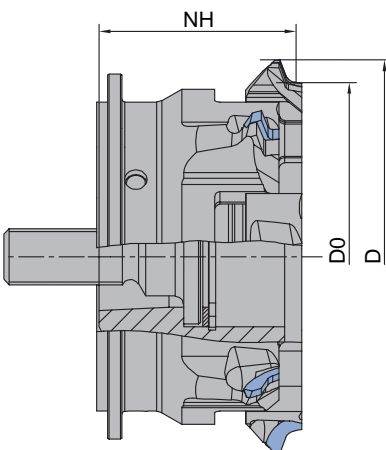



Profile cutter flexTrim3

Application:

For multi-profile cutting with radii on edges. Combination of three profiles for automatic profile resetting.

Machine:

Homag edgebanding machines with cutting unit type FF32 with flexTrim cutting head.

Workpiece material:

Plastic, softwood, hardwood and veneer edgebander.

Technical information:

Three profiles in one tool. Maximum processing quality through high running accuracy and quiet running. D_0 = constant reference diameter, $RPM n_{max} = 12.000 \text{ min}^{-1}$.

Replacement of tool components only by qualified personnel of the tool or machine manufacturer.

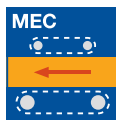

Multi-profile cutterset flexTrim3 - Diamaster PRO

SF 541 2 17

Machine	D	D ₀	NH	BO	Z	QAL	R	FAW	ID	ID
	mm	mm	mm	mm			mm	°	LH	RH
Homag	78	70	28	HSK 25 R	4	DP	2/1,5/1		194500 ●	194501 ●
Homag	78	70	28	HSK 25 R	4	DP	2/1,3/1		194502 ●	194503 ●
Homag	78	70	28	HSK 25 R	4	DP	2/1	45	194514 ●	194515 ●
Homag	78	70	28	HSK 25 R	4	DP	2/1,3	45	194518 ●	194519 ●

Further profile variants and combinations possible on request. Single tools available on request.

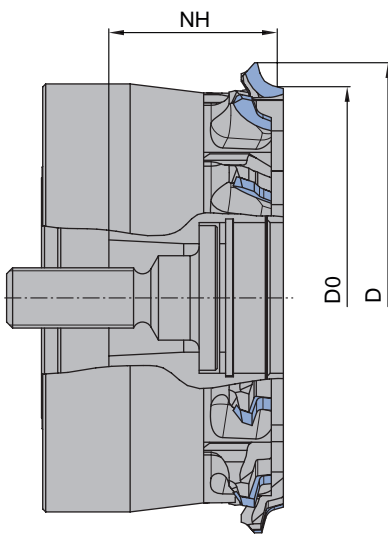

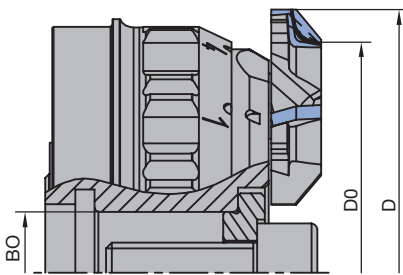
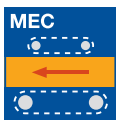
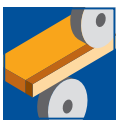
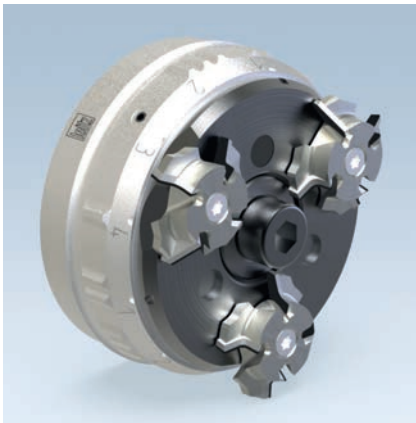

Profile cutter Quattro^{Form}

Application:

For multi-profile cutting with radii and bevelling of edges. Combination of four profiles for automatic profile resetting.

Machine:

Holz-Her model Lumina and Accura 2015 and newer models. Application on revolver cutting unit Quattro Form (FF 701 Multi).

Workpiece material:

Plastic, softwood, hardwood and veneer edgebander.

Technical information:

DP composite tool with four profiles and mounting screw. Profiles automatically adjustable by the machine control. Patented system. D_0 = constant reference diameter, $RPM\ n = 18000\ min^{-1}$. It is recommended to have individual tools changed by the Leitz tool service.

Multi-profile cutter Quattro^{Form} - Diamaster PRO

SF 540 2 10

Machine	D mm	D ₀ mm	BO mm	Z	R mm	FAW °	ID	
							LH	RH
Holz-Her FF 701 Multi	70	61	16	3	2/1,3/2	45	193901 ●	193900 ●
Holz-Her FF 701 Multi	70	61	16	3	3/1,3/2	45	193903 ●	193902 ●
Holz-Her FF 701 Multi	70	61	16	3	3/1,3/2	10	193905 ●	193904 ●
Holz-Her FF 701 Multi	70	61	16	3	2/1,3/1,3	45	193907 ●	193906 ●
Holz-Her FF 701 Multi	70	61	16	3	2/1,5/1	45	193909 ●	193908 ●
Holz-Her FF 701 Multi	70	61	16	3	0,8/1/1,3	45	193911 ●	193910 ●
Holz-Her FF 701 Multi	70	61	16	3	3/2/2	45	193913 ●	193912 ●
Holz-Her FF 701 Multi	70	61	16	3	2/1,3	45	193915 ●	193914 ●
Holz-Her FF 701 Multi	70	61	16	3	2/1,3/2/1,3		193917 ●	193916 ●
Holz-Her FF 701 Multi	70	61	16	3	2/1/2	45	193919 ●	193918 ●
Holz-Her FF 701 Multi	70	61	16	3	2/1,3/1,3/1,3		193921 ●	193920 ●
Holz-Her FF 701 Multi	70	61	16	3	2/3/2/3		193923 ●	193922 ●

All tools and further profile variants are available in various dimensions from blanks at short notice. Profile radius maximum 3 mm.

Spare parts:

BEZ	ID
Maintenance set Quattro Form	008383 ●

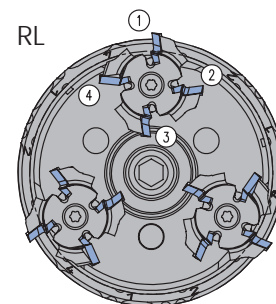
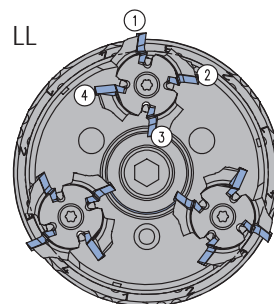

①	②	③	④	Leitz-Id.	Holzher
R2	R1.3	R2	F45°	193901	5073457
R3	R1.3	R2	F45°	193903	5073459
R3	R1.3	R2	F10°	193905	5073462
R2	R1.3	R1.3	F45°	193907	5073465
R2	R1.5	R1	F45°	193909	5073467
R0.8	R1	R1.3	F45°	193911	5073469
R3	R2	R2	F45°	193913	5073471
R2	R1.3	F45°	F45°	193915	5073474
R2	R1.3	R2	R1.3	193917	5073447
R2	R1	R2	F45°	193919	5073450
R2	R1.3	R1.3	R1.3	193921	5073454
R2	R3	R2	R3	193923	5073452

①	②	③	④	Leitz-Id.	Holzher
R2	R1.3	R2	F45°	193900	5073458
R3	R1.3	R2	F45°	193902	5073461
R3	R1.3	R2	F10°	193904	5073463
R2	R1.3	R1.3	F45°	193906	5073466
R2	R1.5	R1	F45°	193908	5073468
R0.8	R1	R1.3	F45°	193910	5073470
R3	R2	R2	F45°	193912	5073473
R2	R1.3	F45°	F45°	193914	5073475
R2	R1.3	R2	R1.3	193916	5073449
R2	R1	R2	F45°	193918	5073451
R2	R1.3	R1.3	R1.3	193920	5073456
R2	R3	R2	R3	193922	5073453



Profile cutter Multi-Edge

Application:

For multi-profile cutting with radii of edges. Combination of three profiles for automatic profile resetting.

Machine:

Stefani.

Workpiece material:

Plastic, softwood, hardwood and veneer edgebander.

Technical information:

Three profiles in one tool. DFC design for efficient chip collection. Maximum processing quality through high running accuracy and smooth running. D_0 = constant reference diameter, $RPM\ n_{max} = 18000\ min^{-1}$. Tool change while the spindle is running. It is recommended to have individual tools changed by the Leitz tool service.

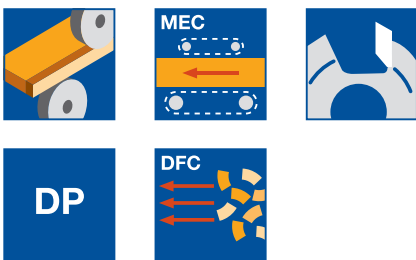

Diamaster PRO

WF 501 2 16

Machine	Tool no.	D mm	D_0 mm	BO mm	Z	QAL	R mm	ID LH	ID RH
Stefani	1	68	61.7	10 DKN	4	DP	1,0	192606 ●	192605 ●
Stefani	1	68	61.7	10 DKN	4	DP	1.3	192608 ●	192607 ●
Stefani	1	68	61.7	10 DKN	4	DP	1.5	192610 ●	192609 ●
Stefani	1	68	61.7	10 DKN	4	DP	2,0	192612 ●	192611 ●
Stefani	1	68	61.7	10 DKN	4	DP	2.5	192614 ●	192613 ●
Stefani	1	68	61.7	10 DKN	4	DP	3,0	192616 ●	192615 ●
Stefani	2	68	61.7	23	4	DP	1,0	192618 ●	192617 ●
Stefani	2	68	61.7	23	4	DP	1.3	192620 ●	192619 ●
Stefani	2	68	61.7	23	4	DP	1.5	192622 ●	192621 ●
Stefani	2	68	61.7	23	4	DP	2,0	192624 ●	192623 ●
Stefani	2	68	61.7	23	4	DP	2.5	192626 ●	192625 ●
Stefani	2	68	61.7	23	4	DP	3,0	192628 ●	192627 ●
Stefani	3	68	61.7	38	4	DP	1,0	192672 ●	192671 ●
Stefani	3	68	61.7	38	4	DP	1.3	192632 ●	192631 ●
Stefani	3	68	61.7	38	4	DP	1.5	192634 ●	192633 ●
Stefani	3	68	61.7	38	4	DP	2,0	192636 ●	192635 ●
Stefani	3	68	61.7	38	4	DP	2.5	192638 ●	192637 ●
Stefani	3	68	61.7	38	4	DP	3,0	192640 ●	192639 ●

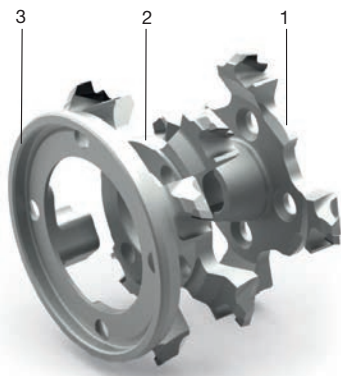

- 1 = tool 1
- 2 = tool 2
- 3 = tool 3

Further profile variants in various dimensions available on request at short notice.



Profile cutterhead / bevel cutterhead

Application:

To round edgebandings.

Machine:

Single or double-sided edgebanding machines.

Workpiece material:

Plastic, softwood, hardwood and veneer edgebander.

Technical information:

Cutterheads with HW knives and cylindrical bore with DKN. The same cutterhead tool body for R 1.5 to 3.0 mm. D_0 = constant reference diameter.

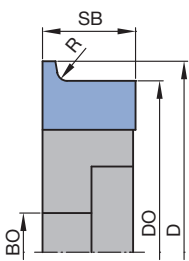
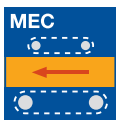
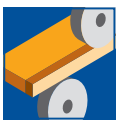

Type 1

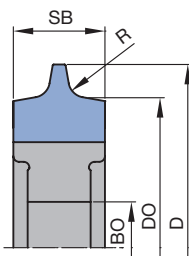

Type 2

Various radii - Brandt, Homag

WE 500 2

Machine	D mm	D_0 mm	SB mm	BO mm	Z	R mm	Type	ID	ID
								LH	RH
Brandt, Homag	56	50	16	16 DKN	4	2	1	075006	075005
Brandt, Homag	58	50	12	16 DKN	4	3	2	075004	075004
Brandt, Homag	78	70	19	16 DKN	4	3	1	075003	075002
Brandt, Homag	82	70	16	16 DKN	4	2	2	075009	075009

Spare knives:

Part-no.	BEZ	ABM mm	QAL	R mm	VE PCS	ID LH	ID RH
1	Exchange knife	16x13,4x2	HW	1.5	10	075325	075324
1	Exchange knife	16x13,4x2	HW	2,0	10	075327	075326
1	Exchange knife	16x13,4x2	HW	3,0	10	075329	075328
1	Exchange knife	19,6x15,2x2	HW	1.5	10	075334	075333
1	Exchange knife	19,6x15,2x2	HW	2,0	10	075336	075335
1	Exchange knife	19,6x15,2x2	HW	2.5	10	075338	075337
1	Exchange knife	19,6x15,2x2	HW	3,0	10	075303	075302
1	Exchange knife	12x13x2	HW	1.5	10	075339	075339
1	Exchange knife	12x13x2	HW	2,0	10	075330	075330
1	Exchange knife	12x13x2	HW	3,0	10	075304	075304
1	Exchange knife	16x17,5x2	HW	1.5	10	009539	009539
1	Exchange knife	16x17,5x2	HW	2,0	10	005132	005132
1	Exchange knife	16x17,5x2	HW	3,0	10	005133	005133

Spare parts:

Part-no.	BEZ	ABM mm	ID
2	Clamping wedge	10x11,5x7	075400
2	Clamping wedge	10x10,9x7	075403
2	Clamping wedge	13,5x11x7	075404
2	Clamping wedge	19	075401
2	Clamping wedge	19	075402
3	Allen screw	M6x12	006035
	Allen key	SW 3	005444
	Setting gauge for knives	43x12x6	005350

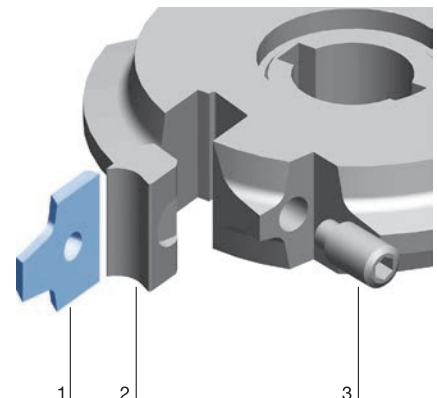



Profile cutterhead / bevel cutterhead

Application:
To round edgebandings.

Machine:
Single or double-sided edgebanding machines.

Workpiece material:
Plastic, softwood, hardwood and veneer edgebander.

Technical information:
Cutterheads with HW knives and cylindrical bore with DKN. One cutterhead basic body for R 1.5 to 3.0 mm. D_0 = constant reference diameter.

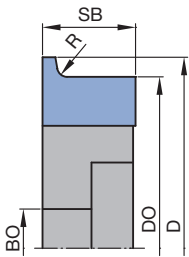
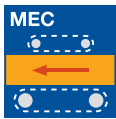
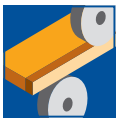

Various radii - Hebrock/EBM

WE 500 2

Machine	D	D_0	SB	BO	Z	R	ID	ID
	mm	mm	mm	mm		mm	LH	RH
Hebrock, EBM	56	49.7	14.5	16 DKN	4	2,0	074559	074560
Hebrock, EBM	56	49.7	14.5	16 DKN	4	2.5	074557	074558

Spare knives:

Part-no.	Type	BEZ	ABM	QAL	R	VE	ID	ID
			mm		mm	PCS	LH	RH
1	1	Combi exchange knife	14.5x14.5x2	HW	2,0	10	074632 ●	074633 ●
1	1	Combi exchange knife	14.5x14.5x2	HW	2.5	10	074630 ●	074631 ●

Spare parts:

Part-no.	BEZ	ABM	ID
		mm	
2	Screw	M3.5x8	005723 ●

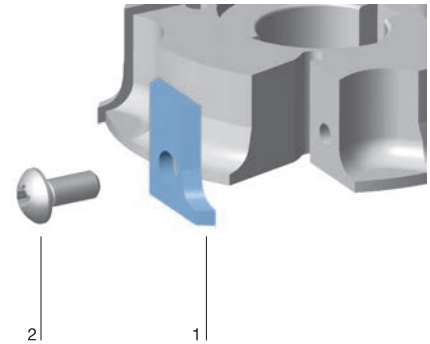



Profile cutterhead / bevel cutterhead

Application:

To round and bevel edgebandings.

Machine:

Single or double-sided edgebanding machines. Machines must be equipped with DFC system.

Workpiece material:

Plastic, softwood, hardwood and veneer edgebander.

Technical information:

Cutterheads with HW knives and cylindrical bore with DKN. D_0 = constant reference diameter. DFC design for highly efficient chip clearance of more than 97%.

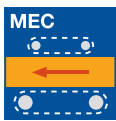
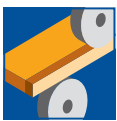

Various profiles - DFC, Brandt, Homag

WE 500 2

Machine	D mm	SB mm	BO mm	Z	R mm	FAW °	ID LH	ID RH
Brandt, Homag	70.23	20.28	16 DKN	4		15	075012 □	075013 □
Brandt, Homag	70.23	20.28	16 DKN	4		30	075014 □	075015 □
Brandt, Homag	69.98	20.28	16 DKN	4		45	075016 □	075017 □
Brandt, Homag	70.57	20.28	16 DKN	4	1,0		075018 □	075019 □
Brandt, Homag	70.57	20.28	16 DKN	4	1.2		075020 □	075021 □
Brandt, Homag	70.57	20.28	16 DKN	4	1.3		075072 □	075073 □
Brandt, Homag	70.57	20.28	16 DKN	4	1.5		075022 □	075023 □
Brandt, Homag	70.57	20.28	16 DKN	4	2,0		075024 ●	075025 ●
Brandt, Homag	70.57	20.28	16 DKN	4	2.5		075026 □	075027 □
Brandt, Homag	70.57	20.28	16 DKN	4	3,0		075028 ●	075029 ●

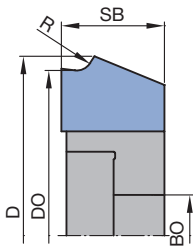

Spare knives:

Part- no.	Type	BEZ	ABM mm	QAL	R	FAW °	VE PCS	ID LH	ID RH
1	1	Exchange knife	22,3x14x2	HW	1,0	10	075315 ●	075314 ●	
1	1	Exchange knife	22,3x14x2	HW	1.2	10	075317 □	075316 □	
1	1	Exchange knife	22,3x14x2	HW	1.3	10	075272 ●	075271 ●	
1	1	Exchange knife	22,3x14x2	HW	1.5	10	075319 ●	075318 ●	
1	1	Exchange knife	22,3x14x2	HW	2,0	10	075307 ●	075306 ●	
1	1	Exchange knife	22,3x14x2	HW	2.5	10	075321 □	075320 □	
1	1	Exchange knife	22,3x14x2	HW	3,0	10	075309 ●	075308 ●	
1	1	Exchange knife	22,3x14x2	HW		15	075311 ●	075310 ●	
1	1	Exchange knife	22,3x14x2	HW		30	075331 □	075332 □	
1	1	Exchange knife	22,3x14x2	HW		45	075313 ●	075312 ●	

Spare parts:

Part-no.	BEZ	ABM mm	ID
2	Oval head screw Torx® 15	M4x6	006225 ●
	Torx® key	Torx® 15	005466 ●

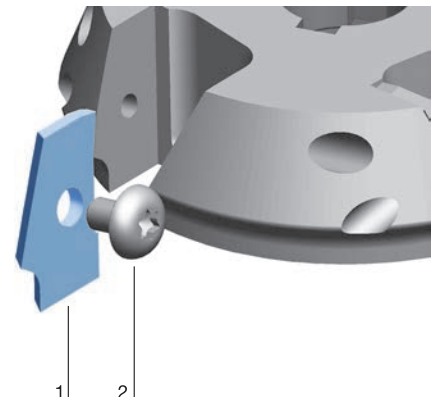

Profile cutterhead / bevel cutterhead

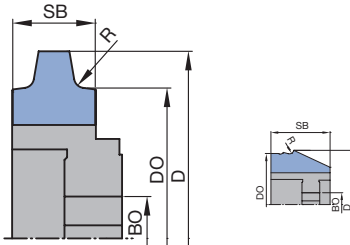
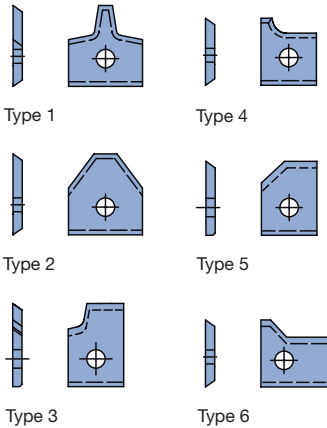

Type 1

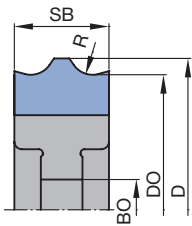

Type 2

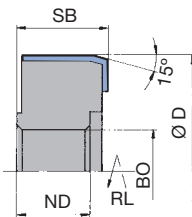

Type 3: WW 500 2 03

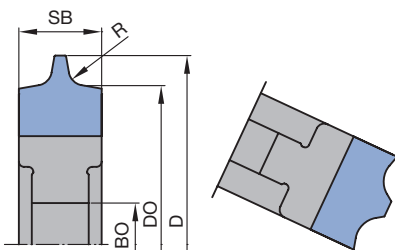

Type 1

Type 2

Profile knives for edge finishing

TM 135 0

SB mm	H mm	DIK mm	QAL	Knife	R mm	FAW °	ID LH	ID RH
16	17.5	2	HW	1	2,0		005132 ●	005132 ●
16	17.5	2	HW	1	3,0		005133 ●	005133 ●
16	17.5	2	HW	1	4,0		005134 ●	005134 ●
16	17.5	2	HW	1	5,0		005135 ●	005135 ●
16	17.5	2	HW	2		45		009525 ●
12	17	2	HW	3	2,0		073554 ●	073555 ●
12	18	2	HW	3	2,0		074033 ●	074034 ●
12	17	2	HW	3	3,0		073558 ●	073559 ●
12	18	2	HW	3	3,0		074035 ●	074036 ●
13	15	2	HW	3	2,0		073505 ●	073504 ●
13	15	2	HW	3	3,0		073509 ●	073508 ●
12	14.5	2	HW	4	2,0		075342 ●	075341 ●
14.5	14.5	2	HW	4	2.5		073543 ●	073544 ●
12	14.5	2	HW	4	3,0		075301 ●	075300 ●
12	16	2	HW	5		45	073541 ●	073540 ●
14.5	14.5	2	HW	6		45		073545 □

Profile knives for system Biesse

TM 135 0

Type	BEZ	ABM mm	QAL	R mm	VE PCS	ID LH	ID RH
1	Exchange knife	16x17x2	HW	1,0	10	074600 □	074600 □
1	Exchange knife	16x17x2	HW	1.5	10	074601 □	074601 □
1	Exchange knife	16x17x2	HW	2,0	10	074602 ●	074602 ●
1	Exchange knife	16x17x2	HW	2.5	10	074603 □	074603 □
1	Exchange knife	16x17x2	HW	3,0	10	074604 □	074604 □
2	Exchange knife	40x17x2	HW	1,0	10	074610 □	074611 □
2	Exchange knife	40x17x2	HW	1.5	10	074612 □	074613 □
2	Exchange knife	40x17x2	HW	2,0	10	074614 □	074615 □
2	Exchange knife	40x17x2	HW	2.5	10	074616 □	074617 □
2	Exchange knife	40x17x2	HW	3,0	10	074618 □	074619 □
3	Exchange knife	20x16x2	HW	1,0	10	074620 □	074620 □
3	Exchange knife	20x16x2	HW	1.5	10	074621 □	074621 □
3	Exchange knife	20x16x2	HW	2,0	10	074622 ●	074622 ●
3	Exchange knife	20x16x2	HW	2.5	10	074623 □	074623 □
3	Exchange knife	20x16x2	HW	3,0	10	074624 □	074624 □

Profile knives for system Holz-Her

TM 435 0

BEZ	ABM mm	QAL	VE PCS	DRI	ID
Turnblade knife	30x12x1,5,PT1,3	HW	10	RH	005088 ●
Turnblade knife	30x12x1,5,PT1,3	HW	10	LH	005089 ●

Profile knives for system Ott

TM 135 0

Type	BEZ	ABM mm	QAL	R mm	VE PCS	ID LH	ID RH
1	Exchange knife	16x16,5x2	HW	1,0	10	074540 □	074540 □
2	Exchange knife	16x17,5x2	HW	1.5	10	009539 ●	009539 ●
1	Exchange knife	16x17,5x2	HW	2,0	10	005132 ●	005132 ●
1	Exchange knife	16x18,5x2	HW	2.5	10	074543 □	074543 □
2	Exchange knife	16x17,5x2	HW	3,0	10	005133 ●	005133 ●
1	Exchange knife	16x19,5x2	HW	3.5	10	074545 □	074545 □
2	Exchange knife	25x15x2	HW	1,0	10	619194 □	619194 □
2	Exchange knife	25x15x2	HW	1.5	10	619195 □	619195 □
2	Exchange knife	25x15x2	HW	2,0	10	619196 ●	619196 ●
2	Exchange knife	25x15x2	HW	2.5	10	619197 □	619197 □
2	Exchange knife	25x15x2	HW	3,0	10	619198 □	619198 □
2	Exchange knife	25x15x2	HW	3.5	10	619202 □	619202 □

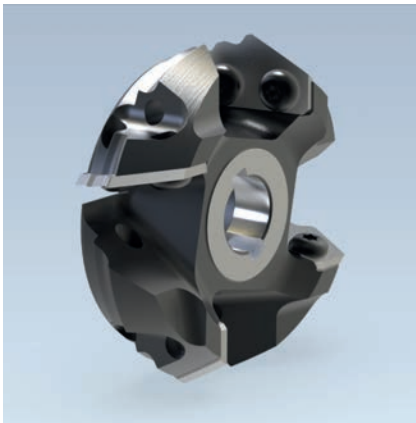

Multi-profile cutterhead / bevel cutterhead

Application:

For a choice of radii or bevels on edgebandings.

Machine:

Single or double-sided edgebanding machines.

Workpiece material:

Plastic, softwood, hardwood and veneer edgebander.

Technical information:

Cutterheads with HW knives and cylindrical bore with DKN. D_0 = constant reference diameter. DFC design for highly efficient chip clearance of more than 97%. Various radii bevel combinations available.

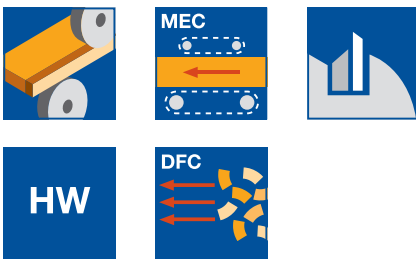

Various profiles - DFC, Homag
WE 500 2

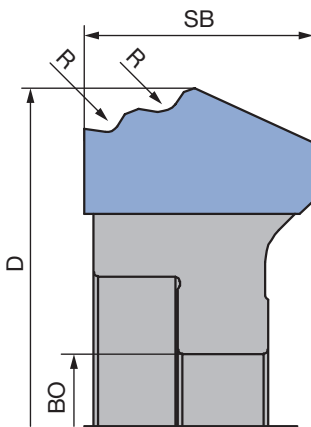

Machine	D mm	SB mm	BO mm	Z	R mm	FAW °	ID LH	ID RH
Homag	74.67	25.28	16 DKN	4	1/2		075092 ●	075093 ●
Homag	74.67	25.28	16 DKN	4	1,3/2		075100 ●	075101 ●
Homag	74.67	25.28	16 DKN	4	1/3		075094 ●	075095 ●
Homag	74.67	25.28	16 DKN	4	2/3		075112 □	075113 □
Homag	74.67	25.28	16 DKN	4	1/1,5		075090 ●	075091 ●
Homag	74.67	25.28	16 DKN	4	1,5/2		075106 □	075107 □
Homag	74.67	25.28	16 DKN	4	1,5/3		075108 □	075109 □
Homag	74.67	25.28	16 DKN	4	1	15	075114 □	075115 □
Homag	74.67	25.28	16 DKN	4	1,3/3		075102 ●	075103 ●
Homag	74.67	25.28	16 DKN	4	2	30	075130 □	075131 □
Homag	74.67	25.28	16 DKN	4	2	15	075120 □	075121 □
Homag	74.67	25.28	16 DKN	4	1/1,3		075088 □	075089 □
Homag	74.67	25.28	16 DKN	4	2	45	075140 □	075141 □
Homag	74.67	25.28	16 DKN	4	1	45	075134 □	075135 □
Homag	74.67	25.28	16 DKN	4	1.3	45	075136 □	075137 □
Homag	74.67	25.28	16 DKN	4	1.5	45	075138 □	075139 □
Homag	74.67	25.28	16 DKN	4	1.5	30	075128 □	075129 □
Homag	74.67	25.28	16 DKN	4	2/2		075110 □	075111 □
Homag	74.67	25.28	16 DKN	4	1,3/1,3		075096 □	075097 □
Homag	74.67	25.28	16 DKN	4	1,5/1,5		075104 □	075105 □
Homag	74.67	25.28	16 DKN	4	1	30	075124 □	075125 □
Homag	74.67	25.28	16 DKN	4	1,3/1,5		075098 □	075099 □
Homag	74.67	25.28	16 DKN	4	1.3	30	075126 □	075127 □
Homag	74.67	25.28	16 DKN	4	3	30	075132 □	075133 □
Homag	74.67	25.28	16 DKN	4	3	45	075142 □	075143 □
Homag	74.67	25.28	16 DKN	4	1/1		075086 □	075087 □

Further radii combinations available at short notice.

Spare knives:

Part- no.	BEZ	ABM mm	QAL	R mm	FAW °	VE PCS	ID LH	ID RH
1	Exchange knife	25.67x16.5x2	HW	1/2		10	075706 ●	075707 ●
1	Exchange knife	25.67x16.5x2	HW	1,3/2		10	075714 ●	075715 ●
1	Exchange knife	25.67x16.5x2	HW	1/3		10	075708 ●	075709 ●
1	Exchange knife	25.67x16.5x2	HW	2/3		10	075726 □	075727 □
1	Exchange knife	25.67x16.5x2	HW	1/1,5		10	075704 ●	075705 ●
1	Exchange knife	25.67x16.5x2	HW	1,5/2		10	075720 □	075721 □
1	Exchange knife	25.67x16.5x2	HW	1,5/3		10	075722 □	075723 □
1	Exchange knife	25.67x16.5x2	HW	1	15	10	075728 □	075729 □
1	Exchange knife	25.67x16.5x2	HW	1,3/3		10	075716 ●	075717 ●
1	Exchange knife	25.67x16.5x2	HW	2	30	10	075744 □	075745 □
1	Exchange knife	25.67x16.5x2	HW	2	15	10	075734 □	075735 □
1	Exchange knife	25.67x16.5x2	HW	1/1,3		10	075702 □	075703 □
1	Exchange knife	25.67x16.5x2	HW	2	45	10	075754 □	075755 □
1	Exchange knife	25.67x16.5x2	HW	1	45	10	075748 □	075749 □
1	Exchange knife	25.67x16.5x2	HW	1.3	45	10	075750 □	075751 □
1	Exchange knife	25.67x16.5x2	HW	1.5	45	10	075752 □	075753 □
1	Exchange knife	25.67x16.5x2	HW	1.5	30	10	075742 □	075743 □
1	Exchange knife	25.67x16.5x2	HW	2/2		10	075724 □	075725 □

2. Panel processing

2.1 Edge processing 2.1.7 Edge finishing tools

Part-no.	BEZ	ABM mm	QAL	R mm	FAW °	VE PCS	ID LH	ID RH
1	Exchange knife	25.67x16.5x2	HW	1,3/1,3		10	075710 □	075711 □
1	Exchange knife	25.67x16.5x2	HW	1,5/1,5		10	075718 □	075719 □
1	Exchange knife	25.67x16.5x2	HW	1	30	10	075738 □	075739 □
1	Exchange knife	25.67x16.5x2	HW	1,3/1,5		10	075712 □	075713 □
1	Exchange knife	25.67x16.5x2	HW	1.3	30	10	075740 □	075741 □
1	Exchange knife	25.67x16.5x2	HW	3	30	10	075746 □	075747 □
1	Exchange knife	25.67x16.5x2	HW	3	45	10	075756 □	075757 □
1	Exchange knife	25.67x16.5x2	HW	1/1		10	075700 □	075701 □

Further radii combinations available at short notice.

Spare parts:

Part-no.	BEZ	ABM mm	ID
2	Oval head screw Torx® 15	M4x6	006225 ●
	Torx® key	Torx® 15	005466 ●

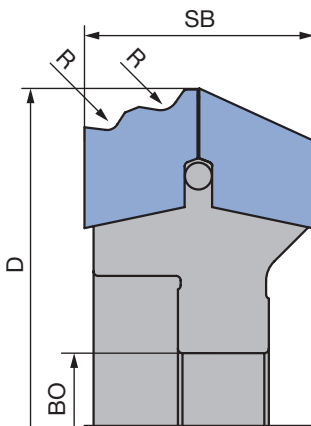
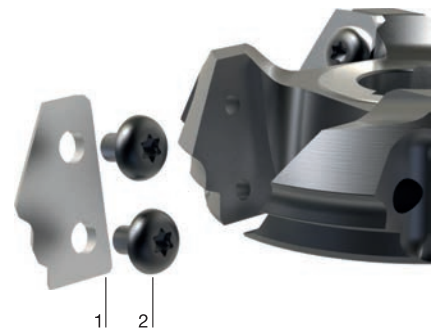

Spare knives - two-part knife design (until 03/2023)

TM 135 0

Type	BEZ	ABM mm	QAL	R mm	FAW °	VE PCS	ID LH	ID RH
1	Exchange knife	17,9x14,2x2	HW	1/1,5		10	075365 □	075366 □
1	Exchange knife	17,9x14,2x2	HW	1/2		10	075347 ●	075348 ●
1	Exchange knife	17,9x14,2x2	HW	1/3		10	075351 ●	075352 ●
1	Exchange knife	17,9x14,2x2	HW	1,3/2		10	075349 ●	075350 ●
1	Exchange knife	17,9x14,2x2	HW	1,3/3		10	075373 ●	075374 ●
1	Exchange knife	17,9x14,2x2	HW	1,5/2		10	075367 ●	075368 ●
1	Exchange knife	17,9x14,2x2	HW	1,5/3		10	075369 ●	075370 ●
1	Exchange knife	17,9x14,2x2	HW	2/3		10	075353 ●	075354 ●
1	Exchange knife	17,9x14,2x2	HW	1	15	10	075371 ●	075372 ●
1	Exchange knife	17,9x14,2x2	HW	2	30	10	075201 ●	075202 ●
2	Exchange knife	18,1x13,5x2	HW			10	075355 ●	075356 ●

Spare parts:

Part-no.	BEZ	ABM mm	ID
3	Oval head screw Torx® 15	M4x6	006225 ●
	Torx® key	Torx® 15	005466 ●

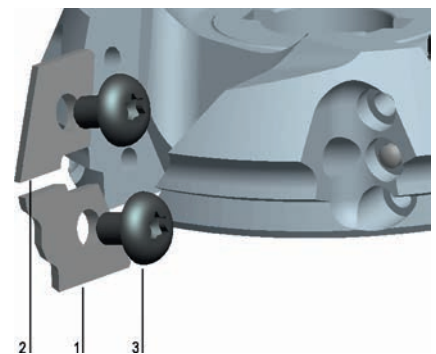



Profile scrapers

Application:

For scraping edgebandings with radii or bevels.

Machine:

Single or double-sided edgebanding machines.

Workpiece material:

Plastic edgebandings.

Technical information:

Bevel and radius scraper for scraper holder.

Profile scrapers

TM 130 0, TM 435 0

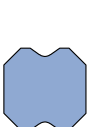
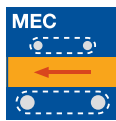

Type 1

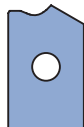

Type 2

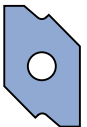

Type 3

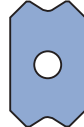

Type 4

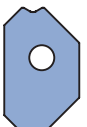

Type 5



Type 6

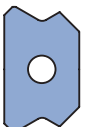

Type 7

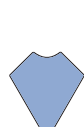

Type 8

Machine	SB mm	H mm	DIK mm	R mm	FAW °	Type	QAL	VE PCS	ID	ID left
Biesse	12.7	12.7	3.18		25	1	HW	10	074552 ●	
Biesse	12.7	12.7	3.18	1,0		1	HW	10	074548 ●	
Biesse	12.7	12.7	3.18	1.5		1	HW	10	074549 ●	
Biesse	12.7	12.7	3.18	2,0		1	HW	10	074550 ●	
Biesse	12.7	12.7	3.18	3,0		1	HW	10	074551 ●	
Fravol	12	20	2	1-3		2	TDC	10	074640 ●	074639 ●
Holz-Her	12	20	2		45	4	HW	10	074037 ●	
Holz-Her	12	20	2	1,0		4	HW	10	074039 ●	
Holz-Her	12	20	2	1.5		4	HW	10	074074 ●	
Holz-Her	12	20	2	2,0		4	HW	10	074040 ●	
Holz-Her	12	20	2	2.5		4	HW	10	074075 ●	
Holz-Her	12	20	2	3,0		4	HW	10	074041 ●	
Holz-Her ZK701	12	19	2		10	3	HW	10	074576 ●	074575 ●
Holz-Her ZK701	12	19	2		45	3	HW	10	074574 ●	074573 ●
Holz-Her ZK701	12	19	2	1,0		3	HW	10	074562 ●	074561 ●
Holz-Her ZK701	12	19	2	1.3		3	HW	10	074564 ●	074563 ●
Holz-Her ZK701	12	19	2	1.5		3	HW	10	074566 ●	074565 ●
Holz-Her ZK701	12	19	2	2,0		3	HW	10	074568 ●	074567 ●
Holz-Her ZK701	12	19	2	2.5		3	HW	10	074570 ●	074569 ●
Holz-Her ZK701	12	19	2	3,0		3	HW	10	074572 ●	074571 ●
Homag	12	20	2		45	4	HW	10	074037 ●	
Homag	12	20	2	1,0		4	HW	10	074039 ●	
Homag	12	20	2	1.5		4	HW	10	074074 ●	
Homag	12	20	2	2,0		4	HW	10	074040 ●	
Homag	12	20	2	2.5		4	HW	10	074075 ●	
Homag	12	20	2	3,0		4	HW	10	074041 ●	
Homag	12	20	2		45	5	HW	10	073724 ●	
Homag	12	20	2	1,0		5	HW	10	073725 ●	
Homag	12	20	2	1.5		5	HW	10	073726 ●	
Homag	12	20	2	2,0		5	HW	10	073727 ●	
Homag	12	20	2	2.5		5	HW	10	073728 ●	
Homag	12	20	2	3,0		5	HW	10	073729 ●	
Homag	20	11.5	2		3	6	HW	10	073717 ●	
Homag	20	11.5	2	1,0		6	HW	10	073713 ●	
Homag	20	11.5	2	1.5		6	HW	10	073714 ●	
Homag	20	11.5	2	2,0		6	HW	10	073715 ●	
Homag	20	11.5	2	3,0		6	HW	10	073716 ●	
IMA	12	20	2		45	4	HW	10	074037 ●	
IMA	12	20	2	1,0		7	HW	10	074044 ●	
IMA	12	20	2	1.5		7	HW	10	074076 ●	
IMA	12	20	2	2,0		7	HW	10	074021 ●	
IMA	12	20	2	2.5		7	HW	10	074077 ●	
IMA	12	20	2	3,0		7	HW	10	074022 ●	
Ott	12	13.3	3.3	1,0		8	HW	10	074653 ●	
Ott	12	13.3	3.3	2,0		8	HW	10	074654 ●	
SCM	12	20	2	2,0		4	HW	10	074040 ●	
Stefani	12.7	12.7	3.18		25	1	HW	10	074552 ●	
Stefani	12.7	12.7	3.18	1,0		1	HW	10	074548 ●	
Stefani	12.7	12.7	3.18	1.5		1	HW	10	074549 ●	
Stefani	12.7	12.7	3.18	2,0		1	HW	10	074550 ●	
Stefani	12.7	12.7	3.18	3,0		1	HW	10	074551 ●	

Additional scrapers available on request at short notice.

2. Panel processing

2.1 Edge processing 2.1.7 Edge finishing tools

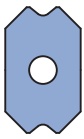

Type 1

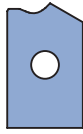

Type 2



Type 3



Type 4

Technical information:

Prevention of stress-whitening and rework through special cutting geometry and quality. Scraper turnblades with different radii for adaption in scraper holder.

Profile scrapers with anti-stress whitening bevel

TM 435 0

Machine	SB mm	H mm	DIK mm	R mm	FAW °	Type	QAL	ID	ID left
Brandt	12	20	2		45	1	HW	074103 ●	
Brandt	12	20	2	1,0		1	HW	074095 ●	
Brandt	12	20	2	1,3		1	HW	074096 ●	
Brandt	12	20	2	1,5		1	HW	074097 ●	
Brandt	12	20	2	2,0		1	HW	074098 ●	
Brandt	12	20	2	2,5		1	HW	074099 □	
Brandt	12	20	2	3,0		1	HW	074100 ●	
EBM	12	20	2		45	1	HW	074103 ●	
EBM	12	20	2	1,0		1	HW	074095 ●	
EBM	12	20	2	1,3		1	HW	074096 ●	
EBM	12	20	2	1,5		1	HW	074097 ●	
EBM	12	20	2	2,0		1	HW	074098 ●	
EBM	12	20	2	2,5		1	HW	074099 □	
EBM	12	20	2	3,0		1	HW	074100 ●	
Fraval	15.44	20	2	1-3		2	TDC	074642 ●	074641 ●
Hebrock	12	20	2	1,0		1	HW	074095 ●	
Hebrock	12	20	2	1,3		1	HW	074096 ●	
Hebrock	12	20	2	1,5		1	HW	074097 ●	
Hebrock	12	20	2	2,0		1	HW	074098 ●	
Hebrock	12	20	2	2,5		1	HW	074099 □	
Hebrock	12	20	2	3,0		1	HW	074100 ●	
Holz-Her	12	20	2		45	1	HW	074103 ●	
Holz-Her	12	20	2	1,0		1	HW	074095 ●	
Holz-Her	12	20	2	1,3		1	HW	074096 ●	
Holz-Her	12	20	2	1,5		1	HW	074097 ●	
Holz-Her	12	20	2	2,0		1	HW	074098 ●	
Holz-Her	12	20	2	2,5		1	HW	074099 □	
Holz-Her	12	20	2	3,0		1	HW	074100 ●	
Homag	12	20	2		45	1	HW	074103 ●	
Homag	12	20	2	1,0		1	HW	074095 ●	
Homag	12	20	2	1,3		1	HW	074096 ●	
Homag	12	20	2	1,5		1	HW	074097 ●	
Homag	12	20	2	2,0		1	HW	074098 ●	
Homag	12	20	2	2,5		1	HW	074099 □	
Homag	12	20	2	3,0		1	HW	074100 ●	
Homag	20	11.5	2	1,0		3	HW	073719 ●	
Homag	20	11.5	2	1,5		3	HW	073720 ●	
Homag	20	11.5	2	2,0		3	HW	073721 ●	
Homag	20	11.5	2	3,0		3	HW	073723 ●	
IMA	12	20	2		45	1	HW	074103 ●	
IMA	12	20	2	1,0		4	HW	074090 ●	
IMA	12	20	2	1,3		4	HW	074101 □	
IMA	12	20	2	1,5		4	HW	074091 ●	
IMA	12	20	2	2,0		4	HW	074092 ●	
IMA	12	20	2	2,5		4	HW	074093 □	
IMA	12	20	2	3,0		4	HW	074094 ●	

Spare parts:

BEZ	ABM mm	ID
Torx® key	Torx® 15	005466 ●
Oval head screw Torx® 15	M4x6	006225 ●

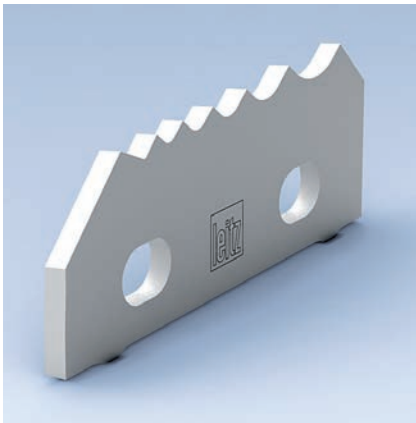

Multi-profile scrapers

Application:

For scraping edgebandings with radii or bevels.

Machine:

Single or double-sided edgebanding machines.

Workpiece material:

Plastic edgebandings.

Technical information:

Multi-profile scraper with a choice of bevels and radii.

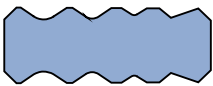
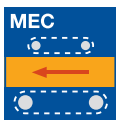
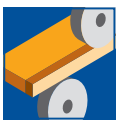

Type 1

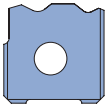

Type 2

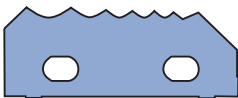

Type 3

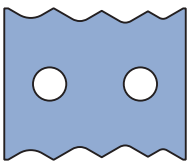

Type 4

Multi-profile scrapers

TM 135 0

Machine	SB mm	H mm	DIK mm	R mm	FAW °	Type	QAL	VE PCS	ID	ID left
Biesse	34	12.7	3	1/2/3	Fase	1	HW		074082 ●	
Brandt	13.5	13.38	2	1/3		2	HW	2	075362 ●	075361 ●
Brandt	13.5	13.38	2	1/2		2	HW	2	075358 ●	075357 ●
Brandt	13.5	13.38	2	1/1,5		2	HW	2	075376 ●	075375 ●
Brandt	13.5	13.38	2	1,3/3		2	HW	2	075380 ●	075379 ●
Brandt	13.5	13.38	2	1,3/2		2	HW	2	075360 ●	075359 ●
Brandt	13.5	13.38	2	1,5/2		2	HW	2	075378 ●	075377 ●
Brandt	13.5	13.38	2	2/3		2	HW	2	075364 ●	075363 ●
Brandt	13.5	13.38	2	2	30	2	HW	2	075398	075397
Homag	13.5	13.38	2	1/3		2	HW	2	075362 ●	075361 ●
Homag	13.5	13.38	2	1/2		2	HW	2	075358 ●	075357 ●
Homag	13.5	13.38	2	1/1,5		2	HW	2	075376 ●	075375 ●
Homag	13.5	13.38	2	1,3/3		2	HW	2	075380 ●	075379 ●
Homag	13.5	13.38	2	1,3/2		2	HW	2	075360 ●	075359 ●
Homag	13.5	13.38	2	1,5/2		2	HW	2	075378 ●	075377 ●
Homag	13.5	13.38	2	2/3		2	HW	2	075364 ●	075363 ●
Homag	13.5	13.38	2	2	30	2	HW	2	075398	075397
Homag	45.8	17.95	2	1/1,5/2/3/5	20	3	HW		074050 ●	074049 ●
IMA	24	20	2	1/1,5/2/3		4	HW		074106 ●	
IMA	24	20	2	1/2/3		4	HW		074107 ●	
Stefani	34	12.7	3	1/2/3	Fase	1	HW		074080 ●	074081 ●

Technical information:

Prevention of stress-whitening and rework through special bevel. Multi-profile scraper with different bevels and radii.

Multi-profile scraper with anti stress-whitening bevel

TM 135 0

Machine	SB mm	H mm	DIK mm	R mm	FAW °	Type	QAL	ID	ID left
Homag	45.8	17.074	2	1/1,5/2/2,5/3	20	3	HW	073105 ●	073104 ●

Further radii combinations with anti-stress whitening bevel available at short time.

Spare parts:

BEZ	ABM mm	ID
Torx® key	Torx® 15	005466 ●
Oval head screw Torx® 15	M4x6	006225 ●

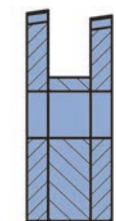
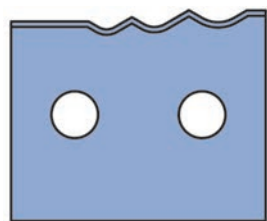
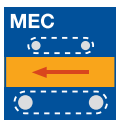
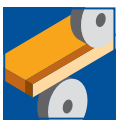

Duo multi-profile scraper Type 1
(all profiles in Duo design)

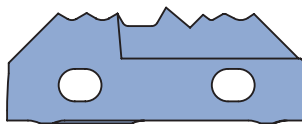
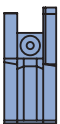

Duo multi-profile scraper Type 2
(2 profiles in Duo design)

Multi-profile scrapers

Application:

For scraping edgebandings with radii or bevels. Especially for colour fastness and anti-stress whitening for dark edges and high gloss PMMA edges.

Machine:

Single or double-sided edgebanding machines or double-end tenoners.

Workpiece material:

Plastic edgebander as PP, ABS, PMMA etc.

Technical information:

Duo multi-profile scraper with different radii and bevels for 4 profiles in total. Staggered cut on two consecutively arranged scrapers with special micro geometry for high edge quality, colour fastness, high gloss level and without stress-whitening. Especially in conjunction with jointless edgebanding.

Attention: Only applicable on standard scraper aggregates with special profile scraper holders.

Duo multi-profile scraper

TM 135 0, TM 435 0

Machine	SB mm	H mm	DIK mm	R mm	FAW °	Type	QAL	ID	ID left
Homag	45.8	19.94	8	1,3/2,0 (Duo) 0,6/1,5	5	2	HW	073731	073730
IMA	24	19.8	8	1/2/3	45	1	HW	074089 ●	074088 ●
IMA	23.7	19.8	8	1,3/1,5/2	45	1	HW	074085 ●	074084 ●

Further radii combinations available at short notice.

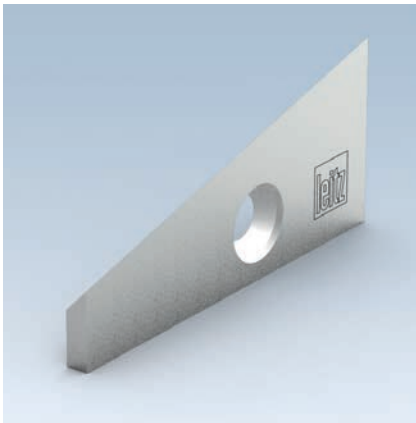

Flat scrapers

Application:

For scraping edgebandings and glue.

Machine:

Single or double-sided edgebanding machines.

Workpiece material:

Plastic edgebandings.

Technical information:

Different profile flat scrapers.

Flat scraper knives

TC 105 0, TM 135 0, TM 405 0, TM 440 0, TM 480 0

Machine	SB mm	H mm	DIK mm	FAW °	Type	QAL	VE PCS	ID	ID left
Biesse	16	16	4.7		1	HW		074556 ●	
Biesse	22.9	22.9	2.5		2	HW		074555 ●	
Brandt	15	14.3	2.5	6	3	HW		074501 ●	074500 ●
EBM	36	30	3		4	HW		074635	074634
Fravol	20	12	1.5		5	HW		074638 ●	
Hebrock	36	30	3		4	HW		074635	074634
Holz-Her	14	14	2		1	HW		009546 ●	
Homag	14.3	14.3	2.5		1	HW	10	005426 ●	
Homag	15	14.3	2.5	6	3	HW		074501 ●	074500 ●
Homag	32	55	4.5	15	6	HW		074048 ●	074047 ●
IMA	14.3	14.3	2.5		1	HW		074305 ●	
IMA	55	25	3	15	7	HW		074024 ●	074023 ●
IMA BAZ	11	14.3	2.5		5	HW		074306 ●	
Ott	15	14.3	2.5	6	3	HW		074501 ●	074500 ●
SCM	14	14	2		1	HW-F	10	005099 ●	

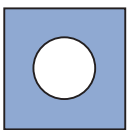
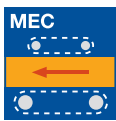
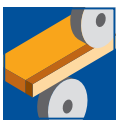

Type 1

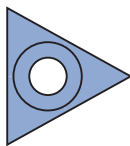

Type 2

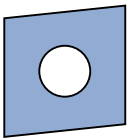

Type 3

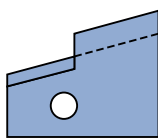

Type 4

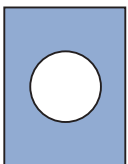

Type 5

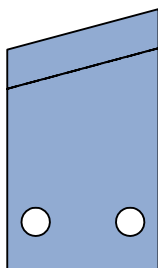

Type 6

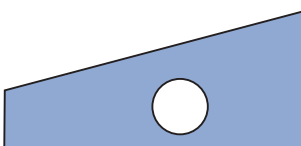

Type 7

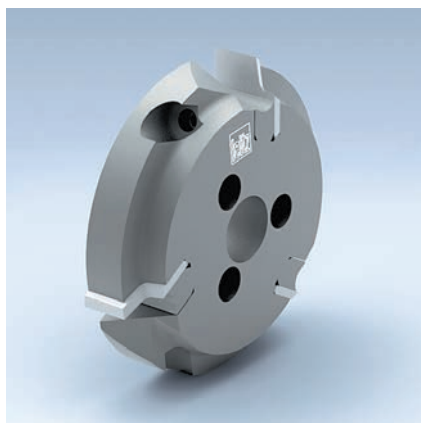

Profile cutterhead / bevel cutterhead for stationary machines

Application:
To round/bevel edgebandings.

Machine:
Homag BAZ.

Workpiece material:
Plastic, softwood, hardwood and veneer edgebander.

Technical information:
Cutterheads with HW knives for edge trimming cutter aggregate. Tool centering at recess diameter 19 mm. The same cutterhead tool body suitable for R 1.0 to 3.0 mm. D_0 = constant reference diameter.

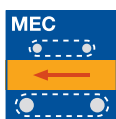

Various radii / bevels - Homag WE 500 2

D	D ₀	BO	NLA	Z	QAL	R	FAW	Type	n _{max}	ID	ID
mm	mm	mm	mm			mm	°		min ⁻¹	LH	RH
59	50	15	3/4,2/25	3	HW	1,0		1	18,000	073001	073000
59	50	15	3/4,2/25	3	HW	1,5		1	18,000	073003	073002
59	50	15	3/4,2/25	3	HW	2,0		1	18,000	073005	073004
59	50	15	3/4,2/25	3	HW	3,0		1	18,000	073009	073008
60	50	15	3/4,2/25	3	HW		15	2	18,000	073037	073036
60	50	15	3/4,2/25	3	HW		30	2	18,000	073039	073038
60	50	15	3/4,2/25	3	HW		45	2	18,000	073041	073040
62	50	15	3/4,2/25	3	HW		15	3	18,000	073101	073100

Type 3 for special thin edgebandings.

Spare knives:

Part-no.	SB	H	DIK	QAL	R	FAW	Type	ID	ID
	mm	mm	mm		mm	°		LH	RH
1	13	15	2	HW	1,0		1	073501	073500
1	13	15	2	HW	1,5		1	073503	073502
1	13	15	2	HW	2,0		1	073505	073504
1	13	15	2	HW	3,0		1	073509	073508
1	12	16	2	HW		15	2	073537	073536
1	12	16	2	HW		30	2	073539	073538
1	12	16	2	HW		45	2	073541	073540
1	14	14	2	HW-F			3	005099	005099

Spare parts:

Part-no.	BEZ	ABM	ID
		mm	
2	Clamping wedge RH	11,5x14,4x7	073400
2	Clamping wedge LH	11,5x14,4x7	073401
3	Allen screw	M6x12	006035
3	Countersink screw, Torx® 20	M6x0.5x4.9	006243
	Allen key	SW 3	005444
	Torx® key	Torx® 20	006091
	Setting gauge for knives	43x12x6	005350

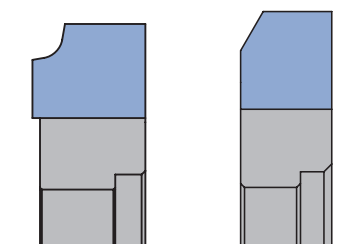

Type 1

Type 2

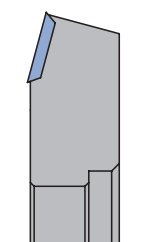

Type 3

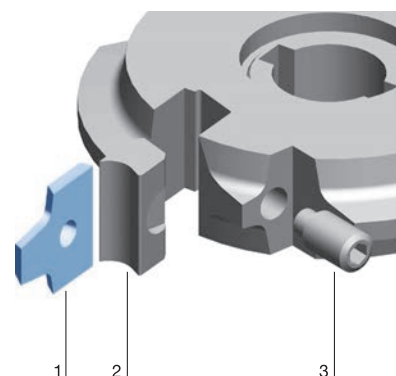

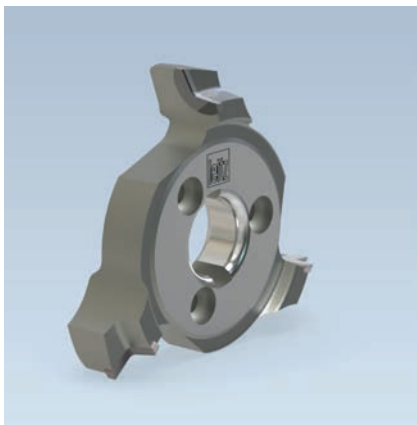

Profile cutter / bevel cutter for stationary machines

Application:
To round/bevel edgebandings.

Machine:
Homag BAZ.

Workpiece material:
Plastic, softwood, hardwood and veneer edgebander.

Technical information:
DP tipped tool with interface for edge trimming cutter aggregate. Tool centering at recess diameter 19 mm. D_0 = constant reference diameter.

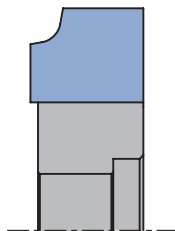
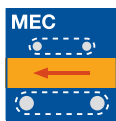

Radii cutter DP - Homag

WF 501 2 DP

D	D_0	BO	NLA	Z	QAL	R	n_{max}	ID	ID
mm	mm	mm	mm			mm	min^{-1}	LH	RH
57	50	15	3/4,2/25	3	DP	2,0	18,000	073103 ●	073102 ●
57	50	15	3/4,2/25	3	DP	3,0	18,000	091522 ●	091523 ●



Profile cutter / bevel cutter for stationary machines

Application:

To round/bevel edgebandings.

Machine:

IMA (BIMA).

Workpiece material:

Plastic, softwood, hardwood and veneer edgebander.

Technical information:

HW tipped profile/bevel cutter, 1 or 2 part design. DP tipped tools available at short notice.

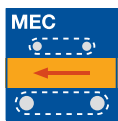
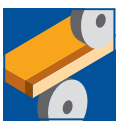

Various radii / bevels - IMA

WF 501 2

D	D ₀	SB	BO	NLA	Z	QAL	R	FAW	n _{max}	ID	ID
mm	mm	mm	mm	mm			mm	°	min ⁻¹	LH	RH
64.4	55	5.8	30	6/5/40	6	HW	1.5		18,000	074062 <input type="checkbox"/>	074063 <input type="checkbox"/>
64.4	55	5.8	30	6/5/40	6	HW	2,0		18,000	074064 <input type="checkbox"/>	074065 <input type="checkbox"/>
64.4	55	5.8	30	6/5/40	6	HW	3,0		18,000	074066 <input type="checkbox"/>	074067 <input type="checkbox"/>
70	60	9	30	6/5/40	6	HW	1.5		18,000	074056 <input type="checkbox"/>	074057 <input type="checkbox"/>
70	60	9	30	6/5/40	6	HW	2,0		18,000	074058 <input type="checkbox"/>	074059 <input type="checkbox"/>
70	60	9	30	6/5/40	6	HW	3,0		18,000	074060 <input type="checkbox"/>	074061 <input type="checkbox"/>
70	60	9	30	6/5/40	6	HW		15	18,000	074068 <input type="checkbox"/>	074069 <input type="checkbox"/>
70	60	9	30	6/5/40	6	HW		30	18,000	074070 <input type="checkbox"/>	074071 <input type="checkbox"/>
70	60	9	30	6/5/40	6	HW		45	18,000	074072 <input type="checkbox"/>	074073 <input type="checkbox"/>

All cutters are available at short notice in 2 part design.

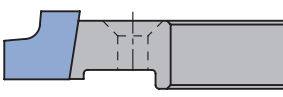
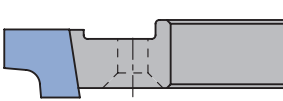
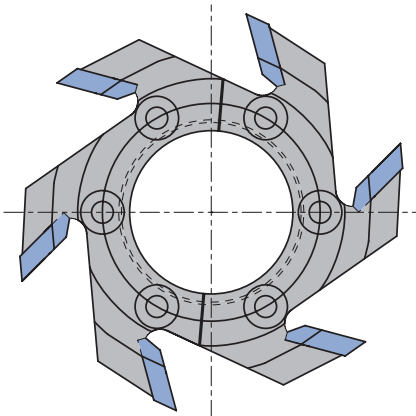

Rebating

Rebating cutter, page 67

Milling off the wooden composite board to uncover the cover layer, application mostly with feed.

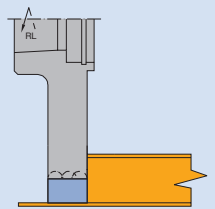

Scoring

Hogging

Compact hogger DT Premium, page 17
Compact hogger DT Premium Score, page 18
Cutting and segment hogger, page 22

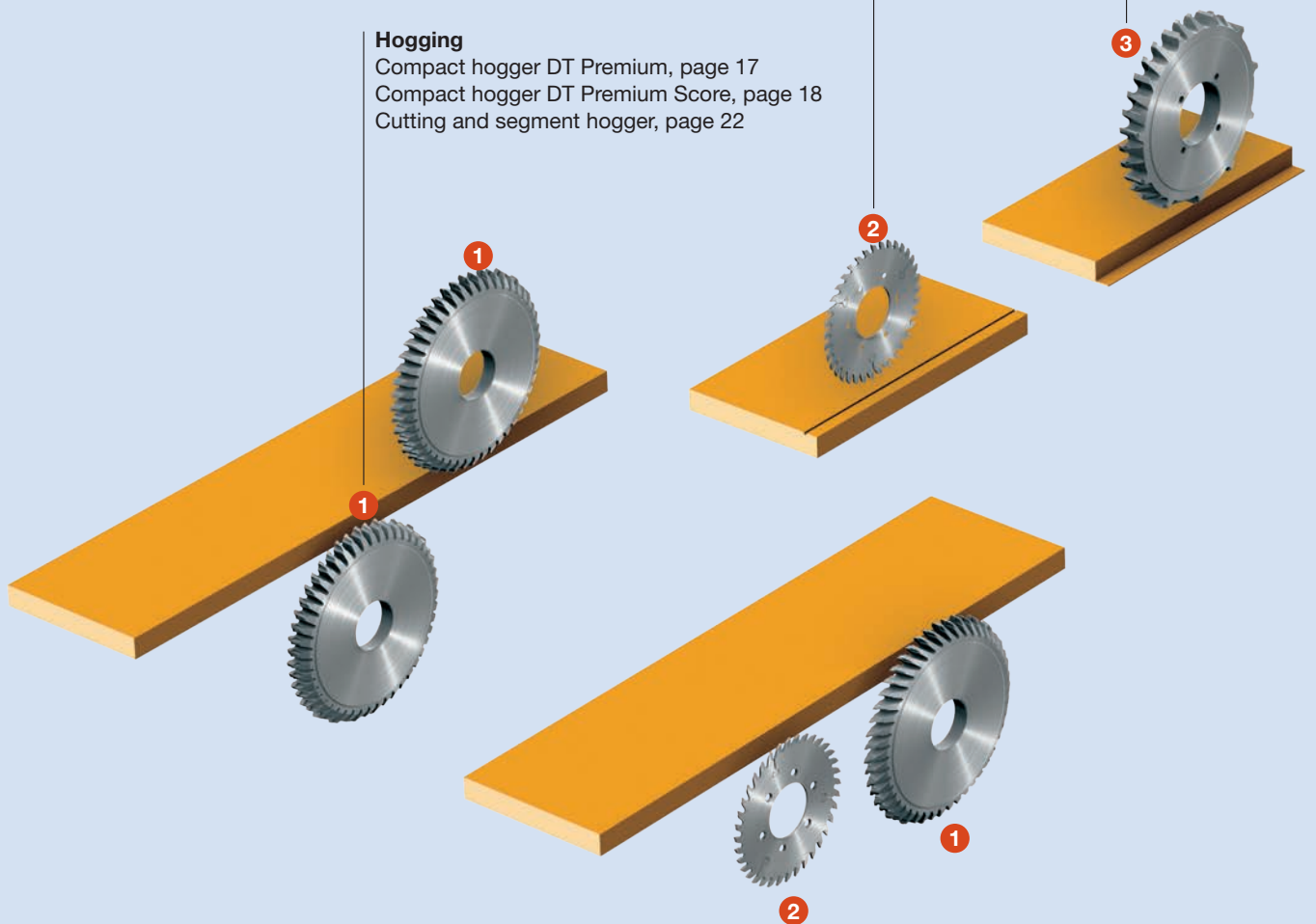

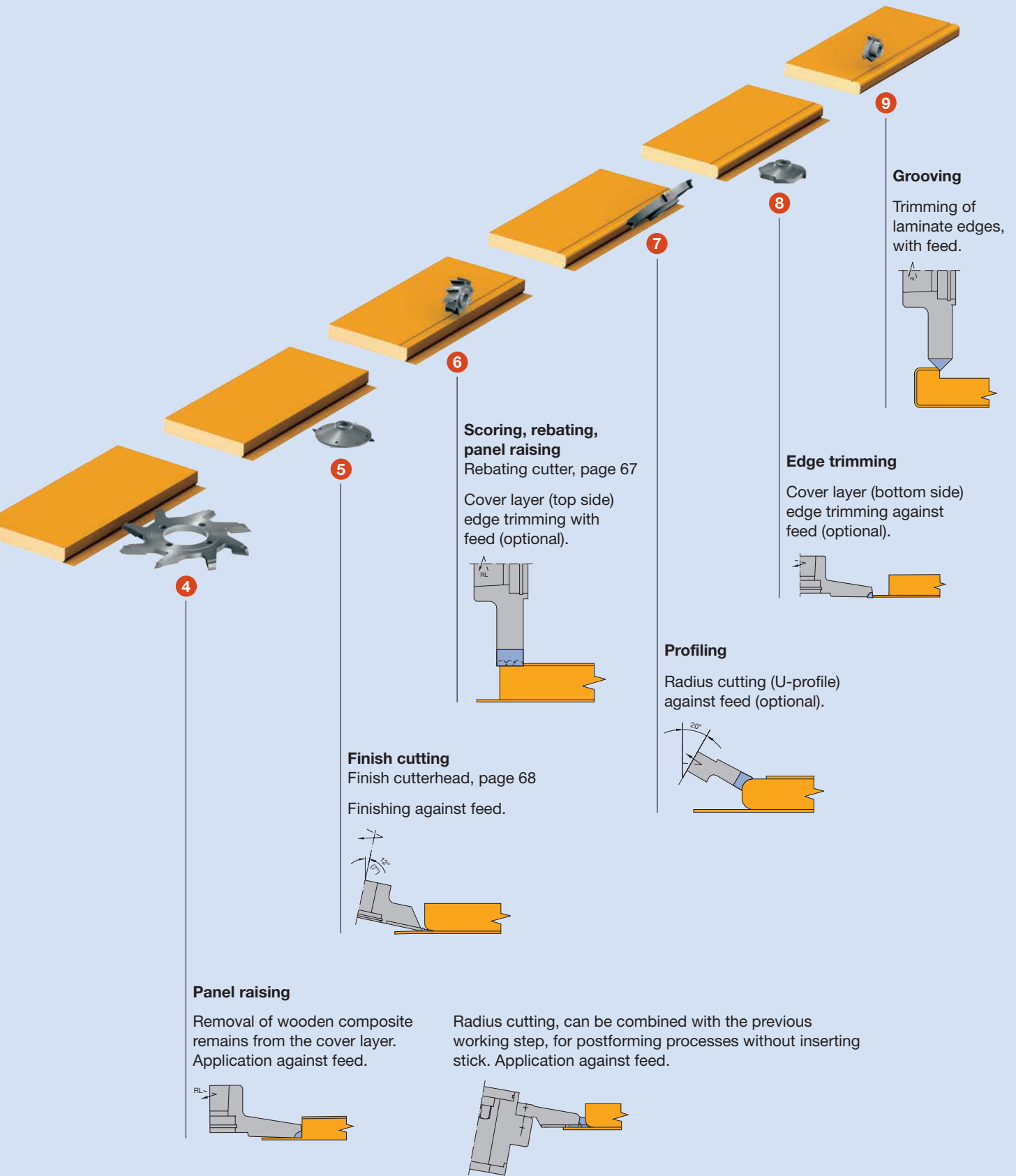

2. Panel processing

2.2 Postforming processing

2.2.2 Postforming tools

Working processes	Production of workpieces with narrow edges for profiling and coating with edging material.
Workpiece material	Chipboard and fibre materials (e.g. MDF boards).
Machines	Single or double-sided soft forming machines.
Procedure	Sizing panel by scoring hogging or double hogging, protection milling, if required. Scoring and removing the coating on the workpiece surface by horizontal spindle. Profiling the narrow edge with vertical, horizontal or inclined spindles. Cutting the edgebanding on the sized side to a precise dimension with the tracing spindle. Edge trimming of the banding on the side banded first with tracing spindle. Scraping, if required.
Important order data	<ul style="list-style-type: none"> - Profile - Coating thickness - Coating material - Machine side - Number of sides to be coated - Expected profile production volume <p>Given the diversity of products, standard tools and special tools are used in soft forming according to requirements.</p>

Profile examples

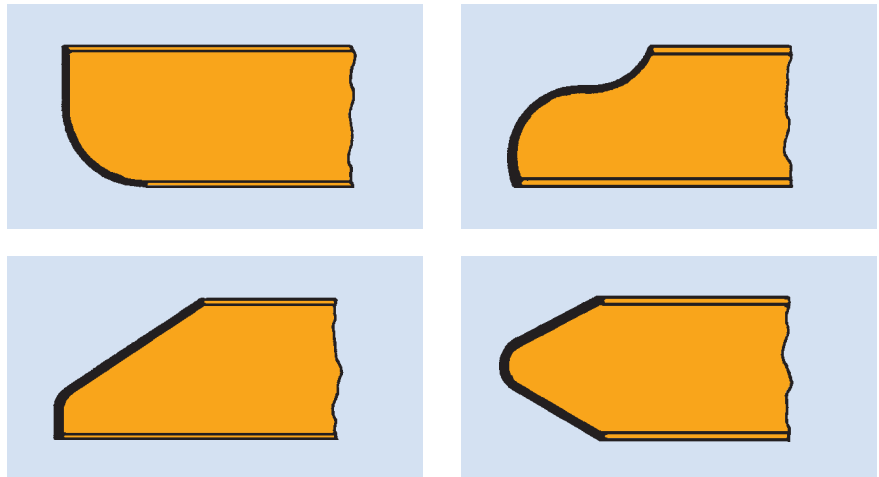

Working process	Production of workpieces with profiled narrow edges with jointless HPL, CPL or veneer surface coating material wrapped around the narrow face.
Workpiece material	Chipboard and fibre materials (e.g. MDF).
Machines	Single or double-sided post forming machines.
Important ordering information	<div style="display: flex; align-items: flex-start;"> <div style="flex: 1;"> </div> <div style="flex: 2;"> <ul style="list-style-type: none"> - Radius and internal radius - Coating thickness - Material thickness - Type of coating - Post forming with or without inlay rod - Machine side <p>R = External radius, e.g. R9 RI = Internal radius, e.g. R8,65</p> </div> </div>

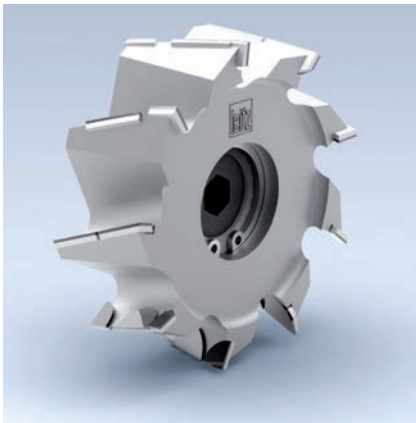

Rebating cutter

Application:

To rebate the core to uncover and trim the edge of the top layer.

Machine:

Postforming machines.

Workpiece material:

HPL, CPL or veneer coated chip and fibre boards (particle board, MDF etc.).

Technical information:

DP tipped tools with HSK 25 R adaptor. High number of teeth removes the need for pre-scoring.

DP tools - 2.0 mm resharpening area.

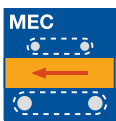

Diamaster PRO

WF 499 2

Machine	D	SB	BO	Z	n_{max}	ID	ID
	mm	mm	mm		min^{-1}	LH	RH
Homag, IMA	70	25	HSK 25 R	9+3	18000	091796	091797

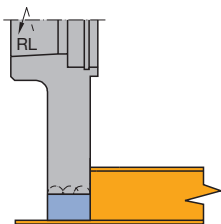

Rebating cutter with HSK 25 R bore:
Machining the laminate layer with horizontal motor

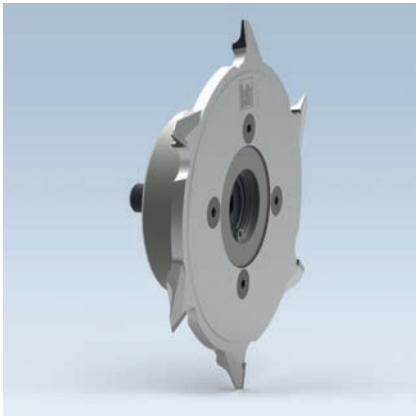

Finishing cutterhead

Application:

For finish cutting of radii on postforming profiles.

Machine:

Postforming units.

Workpiece material:

HPL, CPL or veneer coated chip and fibre boards (chipboard, MDF etc.).

Technical information:

Cutterhead with DP tipped profile knives and HSK 25 R adaptor. Suitable for finish cutting of all radii up to R 14 mm.

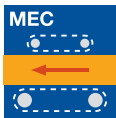

7° inclined spindle

WF 556 2

Machine	D	SB	BO	Z	QAL	n_{max}	Spindle angle	ID	ID
	mm	mm	mm			min ⁻¹	°	LH	RH
Homag, IMA	125	5.1	HSK 25 R	6	DP	12000	7	192666	192667

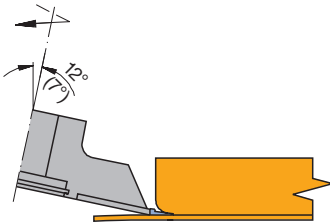

Finish cutting of all radii up to R 14 mm with spindle angle 7°

Technical information:

Spare knives for cutterhead with DP profile knives and cylindrical bore or HSK 25 R adaptor. Suitable for finish cutting radii up to R 14. Non-resharpenable knives 0.5 mm optimised for sensitive coatings, veneer postforming and maximum contour accuracy.

Spare knives for finishing cutterheads

TM 160 0

BEZ	ABM	QAL	ID	ID
	mm		LH	RH
Knife	12x31x2.5x0.5. SB2.5	DP	008208 ●	008204 ●

Spare knives for 7° and 12° inclined spindles.

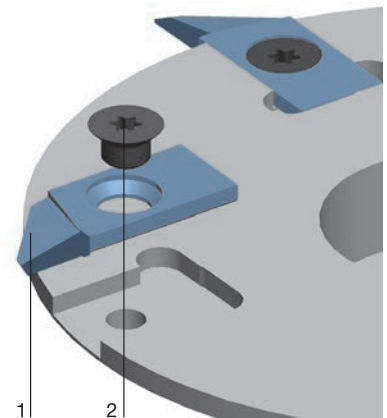

2. Panel processing

2.3 Panel processing

2.3.1 Segment hoggers for sizing

Segment hogger

The cut edge quality of the sizing and finish cuts depends on the circular sawblades. Tool body in steel or aluminium. Staggered cut with tungsten carbide segments. Assembly on flanged sleeve or direct assembly on the motor spindle without flanged sleeve depends on the design.

Designs

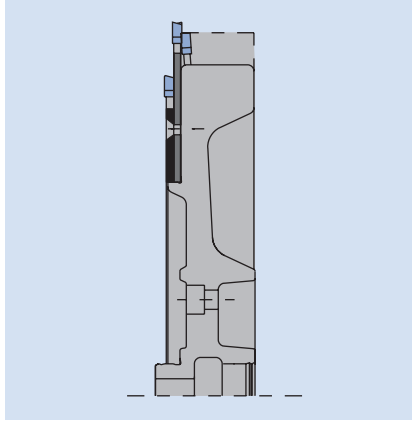

Toolset for finish-production unit with sizing and finish cut

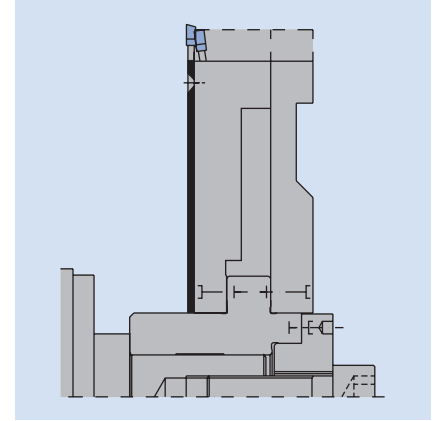

Toolset for sizing unit mounted on flanged sleeve



Segment hogger for sizing unit

Application:

For hogging along and across grain with/without scoring sawblade.

Machine:

Sizing station in production lines.

Workpiece material:

Chip and fibre boards (MDF etc.) uncoated, veneered, plastic coated.

Technical information:

The cut edge quality depends on the circular sawblade. Tool body D 305 mm in steel or D 355 mm in aluminium. Staggered cut with six tungsten carbide segments. Build up option with extension hogger unit. For D 305 mm the hogger is mounted directly on the spindle without flanged sleeve.

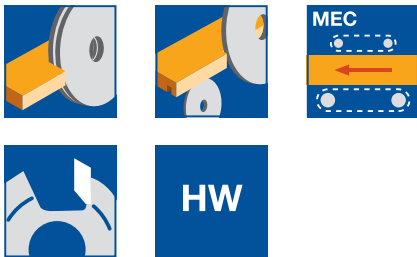

Hogger for sizing unit

SZ 300 2, SZ 301 2

Machine	D	SB	BO	Z/ZF _{Sawblade}	QAL	ID	ID
	mm	mm	mm			LH	RH
Siempelkamp	305	60.1	30	60/ES	HW	064700 <input type="checkbox"/>	064701 <input type="checkbox"/>
Siempelkamp	355	60.5	40 DKN	72/ES	HW	064702	064703

Spare parts:

Part no.	BEZ	ABM	Z	ZF	QAL	BEM	ID
		mm					
	Basic hogger	300x28,0x30	6x7	FZ	HW		064440 ●
	Basic hogger	300x28,0x30	6x7	FZ	HW		064441 ●
	Basic hogger	350x36,5x80	6x10	FZ	HW		064442 <input type="checkbox"/>
	Basic hogger	350x36,5x80	6x10	FZ	HW		064443 <input type="checkbox"/>
	Extension cutter	300x28,0x30	6x7	FZ	HW		064444 ●
	Extension cutter	300x28,0x30	6x7	FZ	HW		064445 ●
	Extension cutter	350x20,2x80	6x10	FZ	HW		064446 ●
	Extension cutter	350x20,2x80	6x10	FZ	HW		064447 ●
	Hogging segment	D 300/340	7	FZ	HW		064970 ●
	Hogging segment	D 300/340	7	FZ	HW		064971 ●
	Hogging segment	D 350	10	FZ	HW		064962 ●
	Hogging segment	D 350	10	FZ	HW		064963 ●
1	Countersink screw, Torx® 20	M6x12				Torx® 20	006084 ●
2	Screw with ISK	M8x17				for D = 250, 350, 305, 355	006237 ●
3	Cylindrical screw with ISK	M8x60				for D = 305	005878 ●
3	Cylindrical screw with ISK	M8x35				for D = 305, 350	005874 ●
3	Cylindrical screw with ISK	M8x25				for D = 355	005947 ●

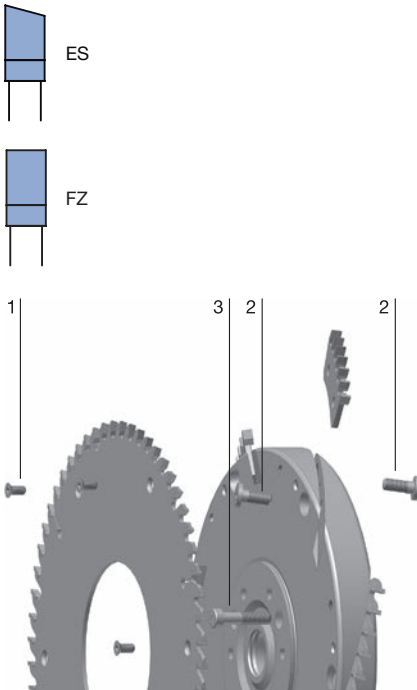

Hogging sawblade

WK 801 2

D	SB	BO	Z	ZF	QAL	ID	ID
mm	mm	mm				LH	RH
305	4.4	120	60	ES	HW	061844 ●	061845 ●
355	4.4	80	72	ES	HW	061846 ●	061847 ●



Segment hogger for splitting unit

Application:

For hogging along and across grain with/without scoring sawblade.

Machine:

Sizing station in production lines.

Workpiece material:

Chip and fibre boards (MDF etc.) uncoated, veneered, plastic coated.

Technical information:

Cut edge quality of the trim and finish cuts is defined by the sawblades. Set assembled with finish cut, trim sawblade and twelve tungsten carbide tipped segments. Staggered cut by twelve hogging segment. The hogger is mounted directly on the motor spindle without flanged sleeve.

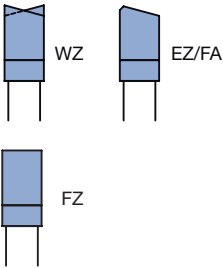

Hogger for splitting unit

SZ 300 2

Machine	D mm	SB mm	BO mm	Z/ZF _{Sawblade}	QAL	ID LH	ID RH
Siempel- kamp	350	42.1	30	60 ES/FA 72 WZ	HW	064704	064705

Spare parts:

Part- no.	BEZ	ABM mm	Z	ZF	QAL	BEM	ID
	Basic hogger	340x34,5x30	12x7	FZ	HW		064448
	Basic hogger	340x34,5x30	12x7	FZ	HW		064449
	Hogging segment	D 300/340	7	FZ	HW		064970 ●
	Hogging segment	D 300/340	7	FZ	HW		064971 ●
1	Countersink screw, Torx® 20	M6x16				Torx® 20	006086 ●
2	Cylindrical screw with ISK	M8x35				for D = 305, 350	005874 ●

Technical information:

D 300 mm finish cut and D 350 mm trimming sawblade.

Hogging sawblade

WK 802 2, WK 850 2

D mm	SB mm	BO mm	Z	ZF	QAL	ID LH	ID RH
300	4.4	200	60	ES/FA	HW	061848 ●	061849 ●
350	4.4	200	72	WZ	HW	061850 ●	061850 ●

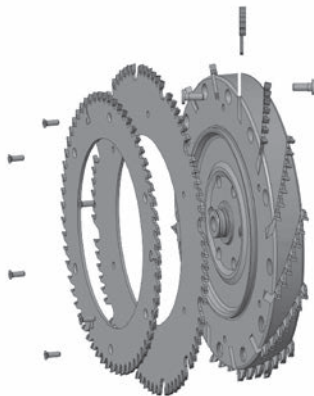

Problem	Possible cause	Action
Break outs at the edge of the workpiece top edge	- Incorrect height adjustment of hogging motor and tilt in feed direction	Correct setting Check position of tools in feed direction, adjust standard value of 0.1 mm to the panel edge
	- Too much axial play in spindle bearing or damaged bearing	Check motor bearings and tolerances
	- Track vibrates due to low chain tension and damaged guides	Check the chain tension, replace damaged parts
	- Incorrect top pressure adjustment	Check top pressure
	- Run out tolerance too high, possible tool imbalance	Measure tool, correct and check for imbalance
	- Insufficient number of teeth, feed rate too high	Increase number of teeth or adjust feed speed
Break outs at the edge of the workpiece bottom edge	- Workpiece projection too large or thin workpieces	Provide additional support in the tool area
	- Incorrect adjustment in feed direction of scoring or hogging tool	Produce trial sample and adjust motors
	- Scoring sawblade not adjusted to the accuracy required in feed direction or hogging tool tilted too far	Check angles of scoring sawblade and hogging tool in feed direction
Tooth pattern at workpiece edge wavy surface	- Tool position setting angle is too high	Correct the tool setting angle
	- Transport of workpiece not consistent during through feed	Check chain and drive
	- Inconstant workpiece feed rate	Increase number of teeth or adjust feed speed
	- Run out tolerance too high, possible imbalanced tool	Measure tool, correct and check for imbalance
Surface of middle layer rough, uneven (with steps)	- Tool worn, blunt	Repair and service the tool
	- Insufficient number of teeth, feed speed too high	Increase number of teeth, adjust feed speed
	- Adjustment of top and bottom tools (scoring/hogging tool) not level with feed direction	Produce trial sample and adjust motors
	- Adjustment of hogging tool not at correct angle to the track	Check angle with dial gauge on the horizontal moving spindle
	- Incorrect tooth shape of tool and angle geometry	Check and correct
	- Insufficient middle layer quality of the workpiece	Improve by removing resin and sharpening more frequently
Break outs at edge of workpiece end grain, front	- Adjustment of jump head to the hogging tool not level with feed direction	Produce trial sample and adjust motors
Break outs at edge of workpiece end grain, back	- Adjustment of the controlled scoring motor not level with the hogging unit in feed direction	Check movement of the jump scoring motor and correct adjustment to the hogging unit
	- Poor quality of middle layer of workpiece material (large chip flow, poor pressing)	Improve by removing resin and sharpening tools more often
	- Insufficient number of teeth, feed speed too high	Increase number of teeth or adjust feed speed
	- Incorrect tooth shape and angle geometry	Check and adjust through resharpening

Rounding of the cutting edge

When hogging solid wood and wood-derived materials with or without coating, the teeth of the hogging sawblade and hogger parts are subject to mechanical and chemical wear.

The surface quality determines the size of the cutting edge abrasion. An extremely worn sawblade tooth requires additional sharpening and reduces the number of possible resharpenings.

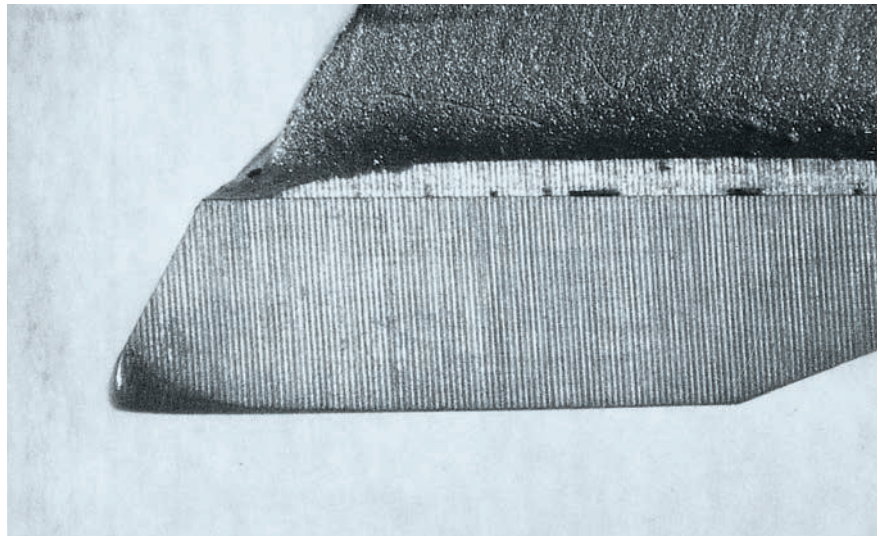

Typical cutting edge wear when machining solid wood.

Cutting edge destruction through improper use

If the relationship between the number of teeth and feed speed is incorrect, the cutting forces will be too high when hogging solid wood, especially with a high moisture content. This leads to choking the gullet and consequently destruction of the saw tooth.

Action:

Reduce the number of teeth to increase the gullet area; adjust feed speed so the cutting quality is still adequate.

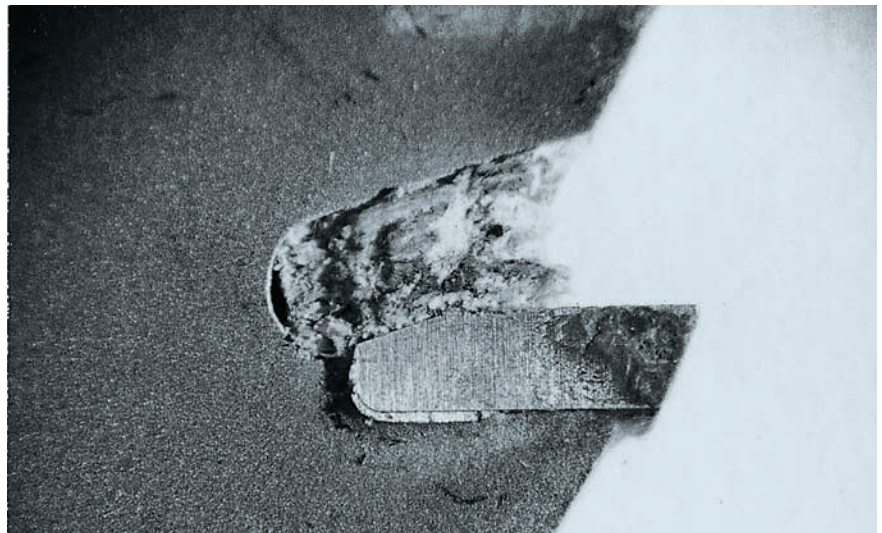

Cutting edge destruction through improper use.

Cutting edge destruction through overstress

If the material to be removed is wider than the cutting width of the hogger, the outside teeth of the raised hogger segments are destroyed by overstress.

The hogging width must always be smaller than the cutting width of the hogging tool.



Destruction of saw tooth through overstress.

Rounding of cutting edges

The illustration opposite shows a typical blunt cutting edge, resulting from mechanical abrasion when machining uniform materials.

Removing the resin from the sides of the teeth between resharpening intervals leads to a considerably longer performance time, as it prevents the loss of side relief.

The area of wear should be approx. 0.2 to max. 0.3 mm.

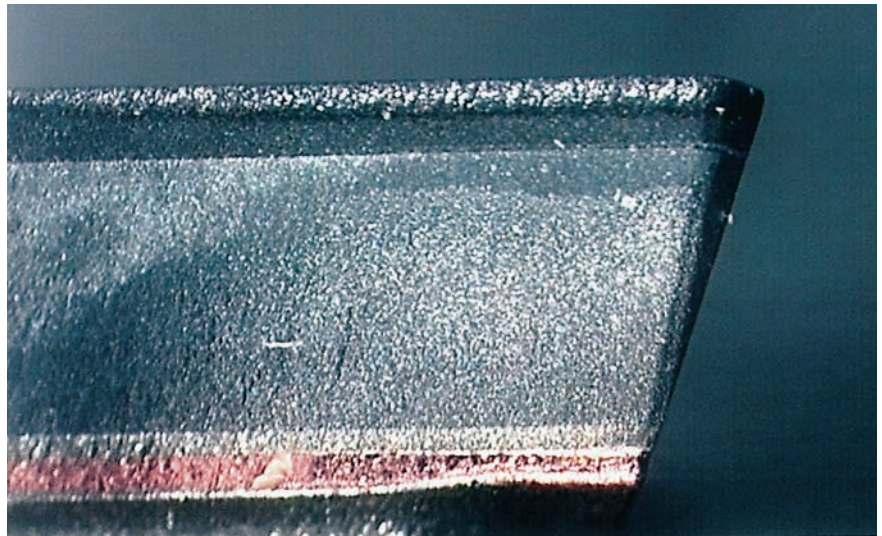

Wear to cutting edges after machining MDF.

Cutting edge rounding and resin build up

Apart from cutting edge wear, a build-up also forms at the side of the teeth from adhesive dust and chip particles (resin build-up) when the workpiece material has a high resin content or the tool has been run for a long time.

This leads to higher cutting forces and power consumption, low surface and middle layer quality and a considerably reduced tool life.

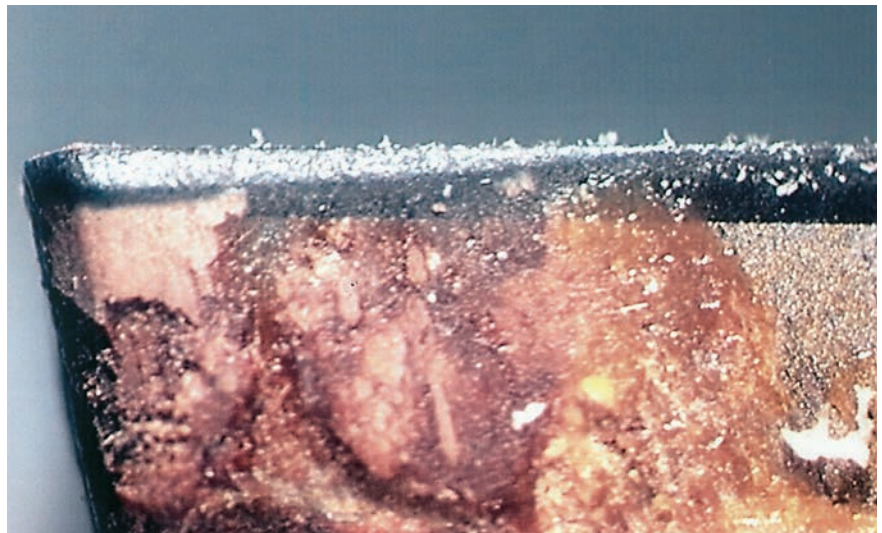

Wear to cutting edges and resin build-up after machining chipboard.

Cutting edge destruction

The cutting edges can be destroyed when machining workpiece materials with a high sand content, a grain size up to 2 - 3 mm diameter (l) or containing metallic particles.

Using DP (DIA) tools when machining such workpiece materials is problematic and use is not recommended for efficient machining.

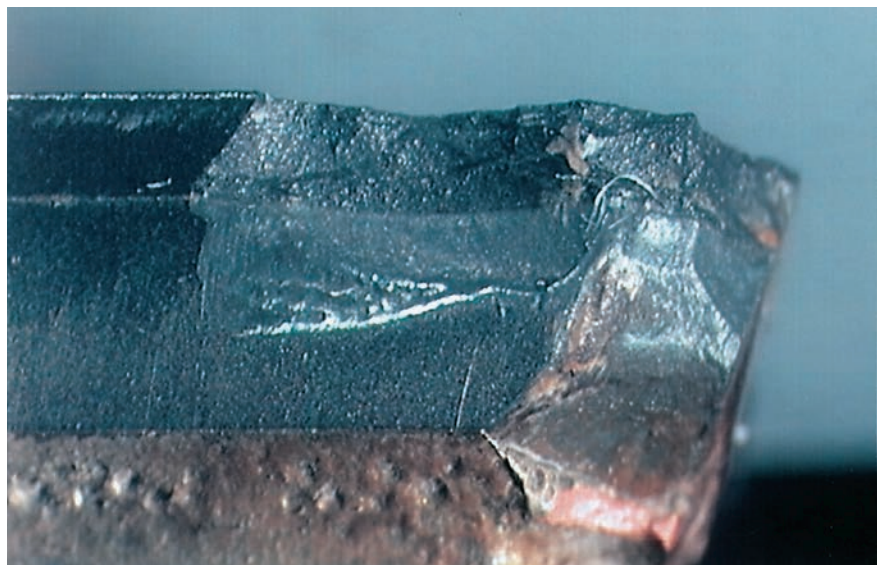

Cutting edge destruction from metallic particles.

Enquiry/order form special tools – panel processing

Customer details: Customer number:

(if known)

Enquiry
 Order

Delivery date: (not binding) CW

Company: _____

Street: _____

Post code/place: _____

Country: _____

Phone/fax: _____

Contact person: _____

Signature: _____

Date: _____

Enquiry/order no.: _____

Tool ID: (if known) _____

No. of pieces: _____

Workpiece material:

Type: _____

Moisture content (of solid wood) _____ %

Direction of machining

along grain across grain

Cutting quality: _____

Pre-hogging

Coating: Yes No

Type (of wood derived material): _____

Hogging width: _____ mm

Material thickness: _____ mm

Finish hogging

Machine:

Manufacturer: _____

Type: _____

Model: _____

Power: _____ kW (HP) motor spindle (see drawing):

RPM: _____ min⁻¹

Feed: _____ m min⁻¹

Hogging motor:

Against feed

With feed

Application scoring/hogging

Application hogging/hogging

Tool:

Tool type (see selection):

Hogging set in cutter design

Hogging set with segments

Compact hogging set

Other

Dimensions:

Diameter _____ mm

Cutting width _____ mm

Bore _____ mm

Adaptor:

Mechanical

Quick change

Hydraulic

No. of teeth:

Hogging sawblade

Hogger

Cutting material:

HW (TC)

DP (DIA)

Please state existing data on tool, machine and workpiece material.

Enquiry/order form special tools – panel processing

Hogging motor/spindle details:



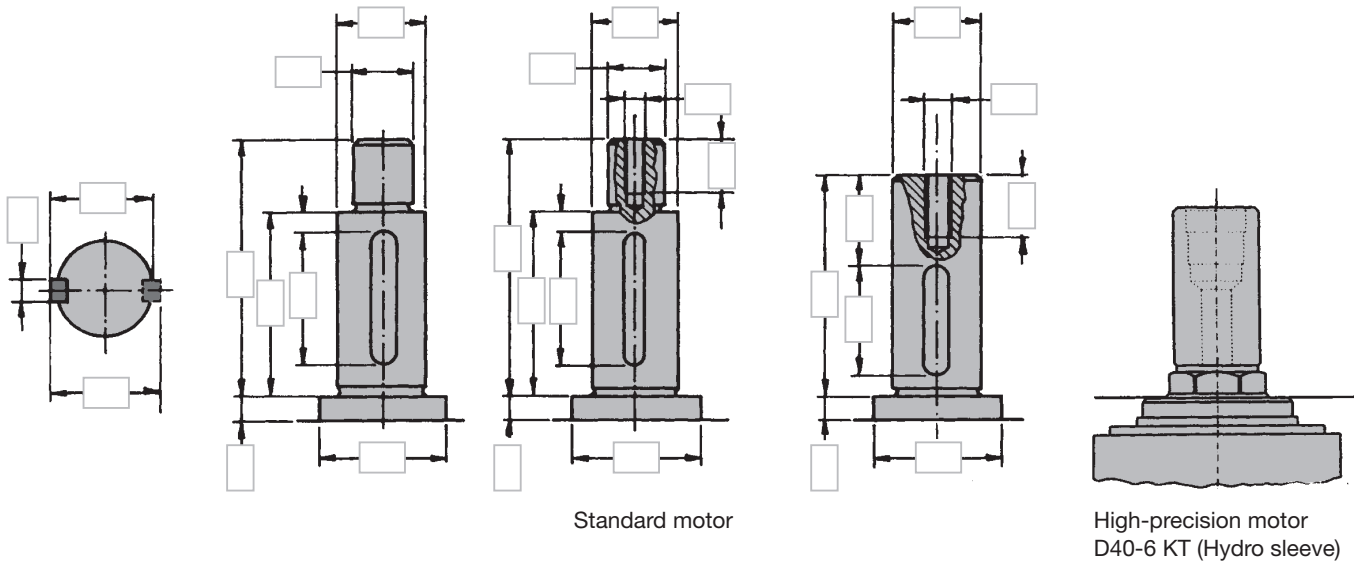















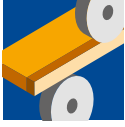

(Enter dimensions on drawing or state in space for sketches)



Sketch for application plan, motor spindle etc.

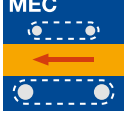

Key to pictograms

	Scoring hogging		Tipped tool
	Hogging		Light alloy body
	Double hogging		Interchangeable knives
	End trimming		Mechanical knife clamping, reversible
	Edge trimming		Resharpenable cutting face
	Grooving, horizontal and vertical		Resharpenable clearance face
	Jointing		Low noise
	Rebating		Optimised chip flow
	Profiling		Tungsten carbide
	Profiling joints		Polycrystalline diamond (PCD)
	Mechanical feed		

